

# Agenda

- 09:00-10:30 Lecture “Basics on BIM for Surveyors” - Prof. Dr.-Ing. Robert Kaden (DVW, Germany)
- 10:30-11:00 Coffee Break
- 11:00-13:00 Best Practice and Research Reports
- 13:00-14:00 Lunch Break
- 14:00-15:00 Active work in groups (choose one)
- 15:00-16:00 Presentation of Groupwork and Discussion
- 16:00-16:30 Closing Note by Commission 10 Chair **Mercy Iyortyer**
- 16:30-18:00 Freshen up
- 18:00-21:00 Workshop Dinner (you are invited) at Roots’n Soul Restaurant Accra

FIG Working Week Pre-Workshop: BIM FOR SURVEYORS  
Basics on BIM for Surveyors

09:15-10:30 CET

Prof. Dr.-Ing. Robert Kaden and  
Prof. Dr.-Ing. Christan Clemen

# AEC – Intension of Modeling

## AEC domain

### – Top-down:



- Design/planning model
- Realization
- Real world

### – Detailed representation of the planned world

### → Modeling of constructive components (elements)

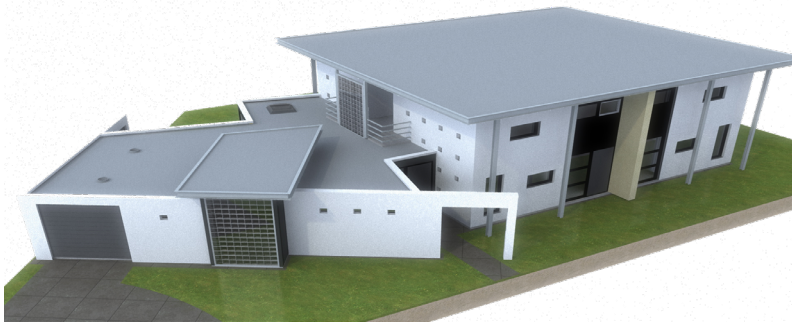

<http://www.tweesnoeken.nl/default.asp?pagelid=433>

# Building Information Modeling (BIM)

- The term Building Information Modeling (BIM) was coined by Autodesk in 1992 to describe the "three-dimensional, object-oriented, AEC-specific, computer-aided design process"
- Since the adoption of the United States National Building Information Modeling Standard (NBIMS) in December 2007, BIM has developed rapidly
- **Method** for planning, construction and operation of buildings
- Supports the active networking of all participants over the life cycle of a building





# The BIM Method

- BIM is a method of optimized, software-supported planning, execution and management of construction projects, based on the active networking of all parties involved in the construction process
- "The core of the method is the creation of digital three-dimensional building models."

**B**uilding – rather built environment, than just buildings

**I**nformation - The **I** makes the difference! Not drawing!

**M**odeling, **M**odel, **M**anagement. . .

## ISO19650: "Building Information Modelling (BIM)...

... use of a shared digital representation of a built object (including buildings, bridges, roads, process plants, etc.) to facilitate design, construction and operation processes to form a reliable basis for decisions" (from ISO 29481-1:2016)

- Clear definitions for the information needed by the project client or asset owner, and for the standards, methods, processes, deadlines and protocols that will govern its production and review
  - The quantity and quality of information produced being just sufficient to satisfy the defined information needs
  - Efficient and effective transfer of information between those involved in each part of the life cycle – particularly within projects and between project delivery and asset operation
- Informed and timely decision making!

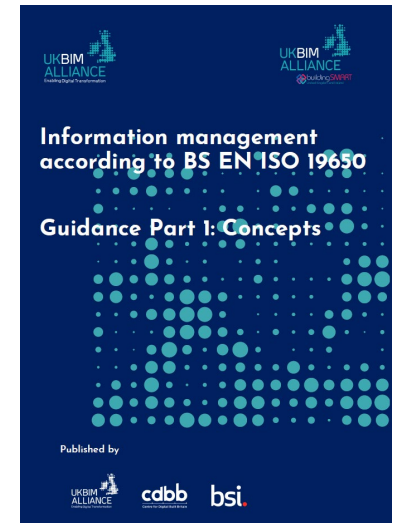

<https://www.ukbimframework.org/standards-guidance/>

# Motivation: Optimization of Costs in Life Cycle

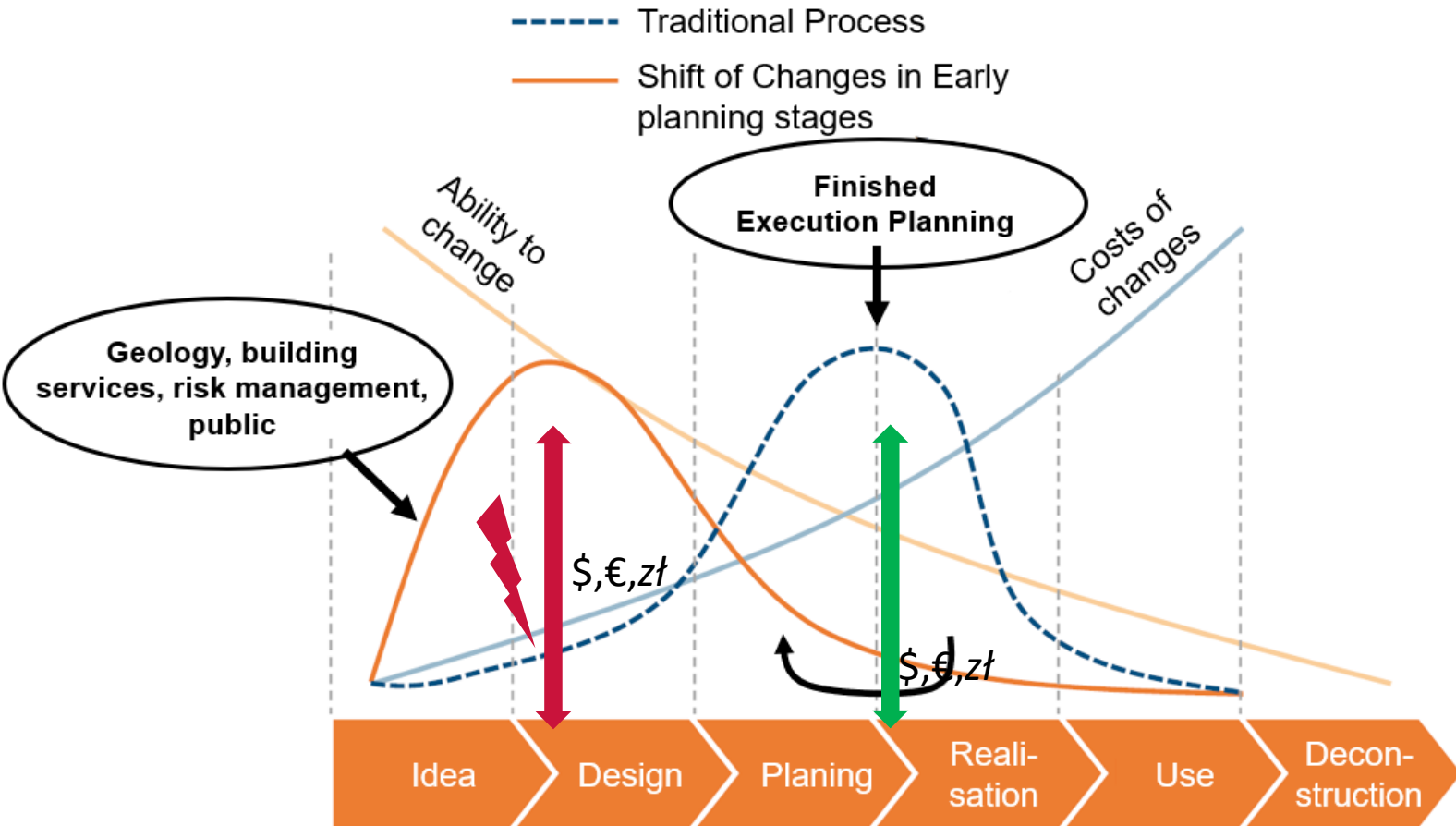

BMVI: Reform Commission Construction of Major Projects - Final Report

# BIM Process According to BS/PAS1192 (Since 2018 ISO 19650 Series)

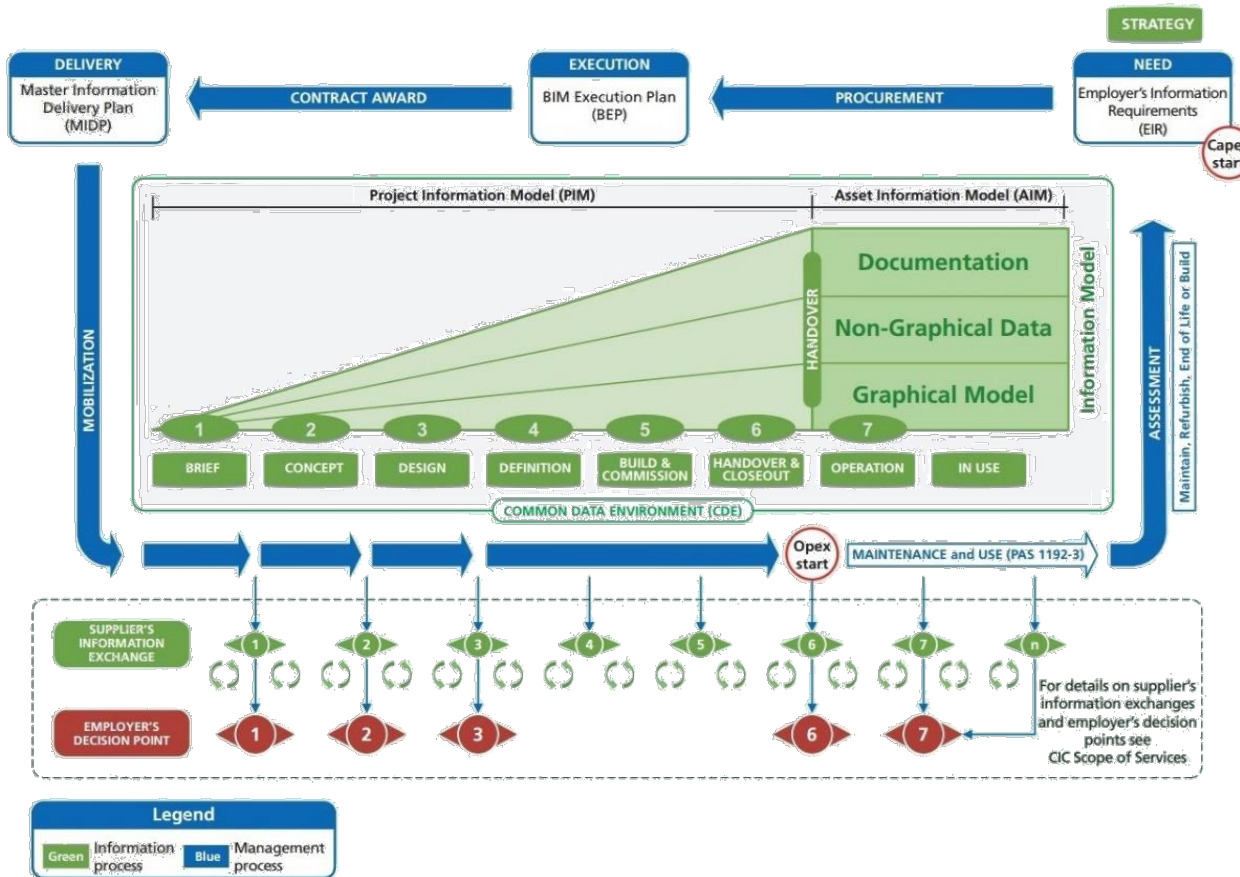

- Common data environment  
Data types, model content
- Framework for management  
EIR, BEP, BIM specifications
- Assignment to "idealized" service phases

# Paradigm Shift: from CAD to BIM

BIM is not a further development of CAD  
 → BIM is based on completely different concepts

- Computer Aided Design (CAD)
  - CAD systems imitate traditional drawing of 2D plans like floor plans, sections and views
  - Simple geometric elements such as lines and arcs as well as lettering
- Building Information Modeling (BIM)
  - The real world structures are imitated in the form of 3D models
  - Composition of complex real-world objects (components), e.g. walls, ceilings, windows

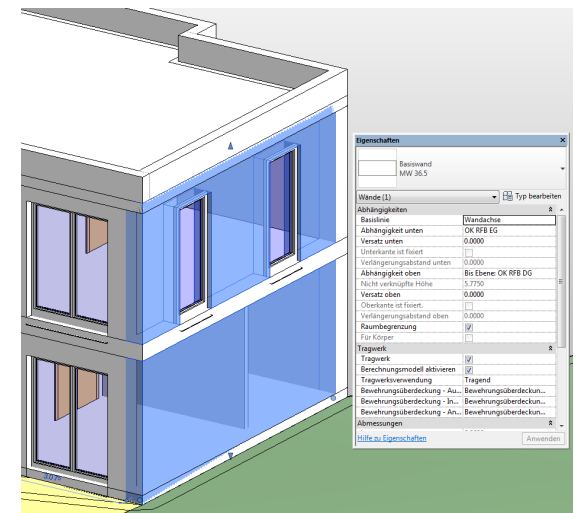
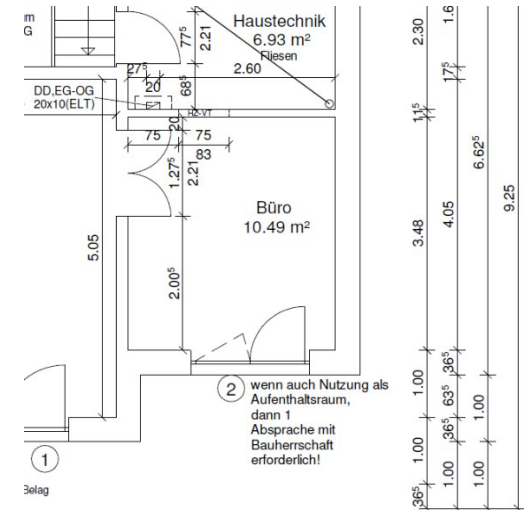

# The Component Makes the Difference! BIM vs. CAD

- Modeling of constructive elements includes complex
  - 3D geometry
  - Semantics
  - Topology
  
- Advantages over CAD
  - Defined process framework vs. "every project is different"
  - Shared data environment vs. data chaos
  - Component orientation vs. drawing
  - Life cycle vs. individual order per service (phase)

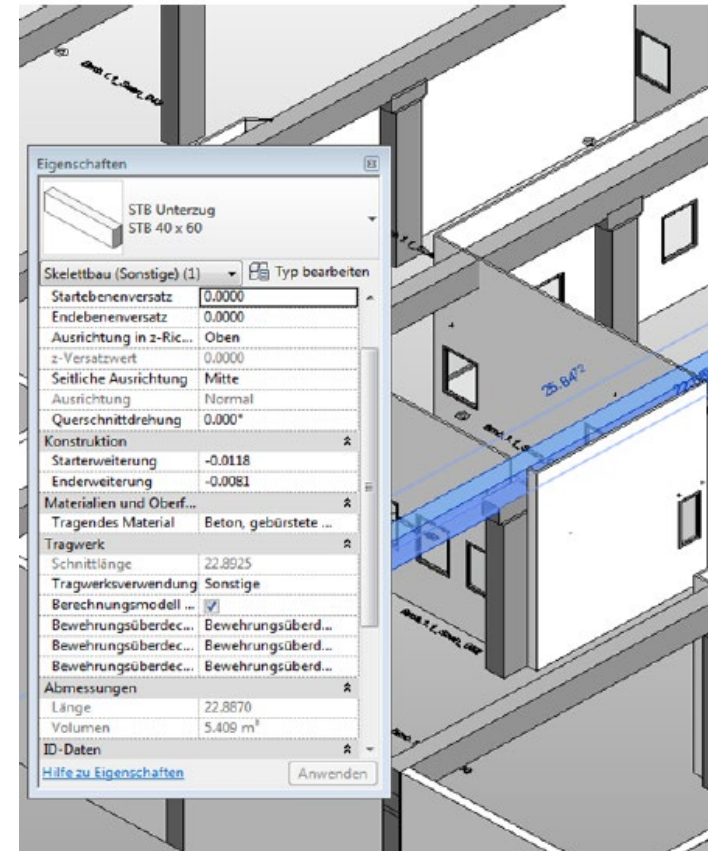



# AEC vs. Geodesy – Intension of Modeling

## AEC Domain

- Top-down:
  - Design/planning model
  - Realization
  - Real world
- Detailed representation of the planned world
- Modeling of constructive components (elements)

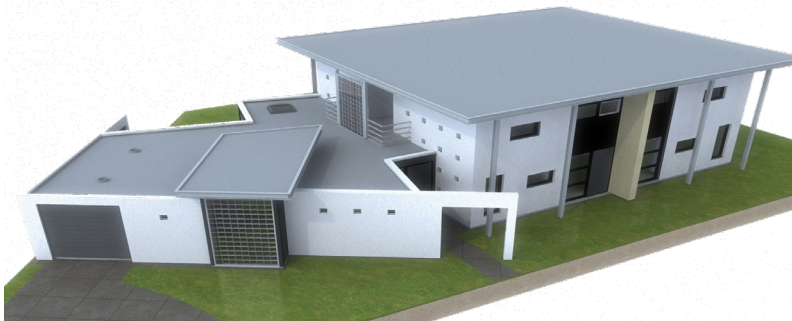

<http://www.tweesnoeken.nl/default.asp?pageId=433>

## Geodesy Domain

- Bottom-up:
  - City/landscape model
  - Abstraction
  - Real world
- Generalized representation of the real world
- Modeling of observable surfaces (object surfaces)



[http://www.dresden.de/media/bilder/vermessung/Canalettoblick\\_3d\\_2015\\_OhneLogo.png](http://www.dresden.de/media/bilder/vermessung/Canalettoblick_3d_2015_OhneLogo.png)

# Scope and Scale Level of Modeling

Influence on thematic content, semantic granularity, geometric resolution and accuracy of the models

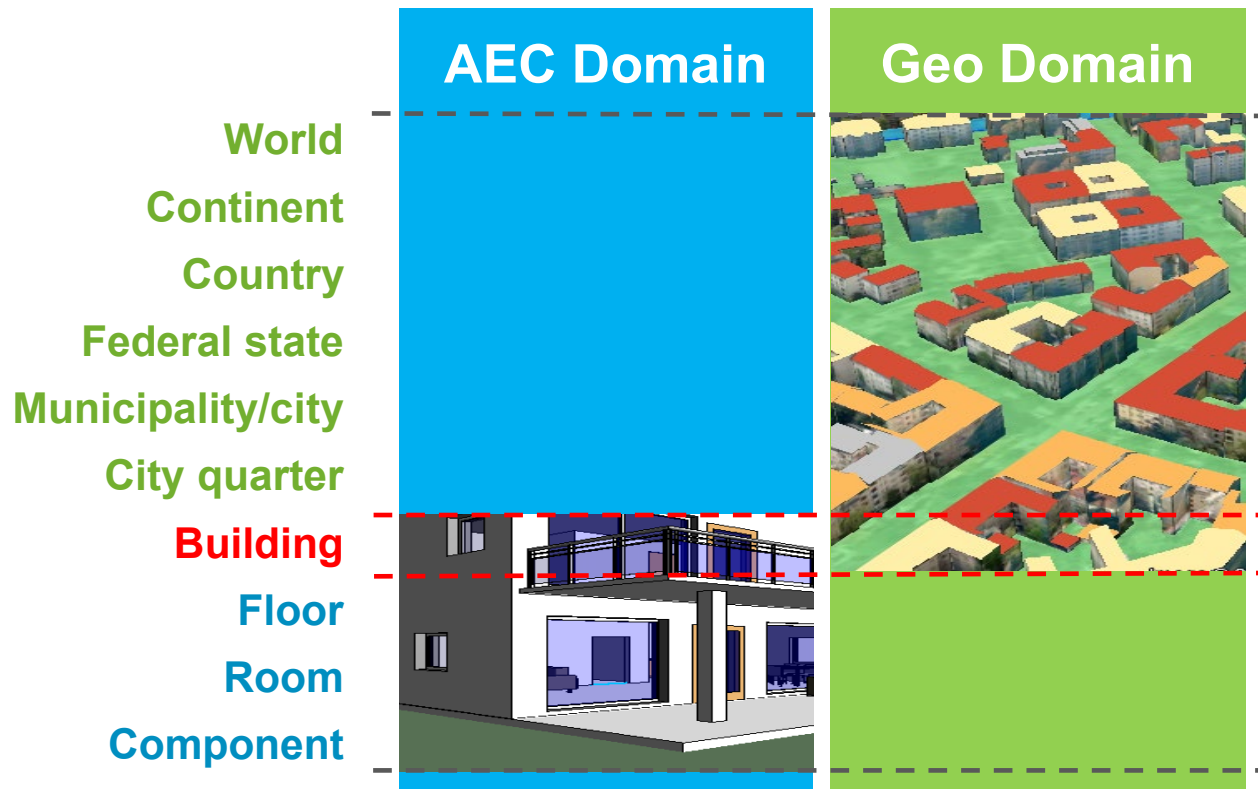



# Georeferencing

Depending on the scope and scale of the model

	<b>AEC Domain</b>	<b>Geo Domain</b>
Type:	<b>PCS (e.g. local WCS)</b>	<b>CRS (e.g. ETRS89/UTM)</b>
Linear Unit:	Arbitrary	meters
Location:	Local (limited)	Global
Zone Limitations:	No	Yes, by UTM zones
Number of Digits:	Small numbers (Origin close to the project site)	Large numbers (7-8 before and 2-3 after decimal point)
Projection Distortion:	No (1:1)	Yes (up to ~ 400ppm)
Height Distortion:	No (1:1)	Yes (depends on height)

# Three-Dimensional Geometry (3D ≠ 3D)

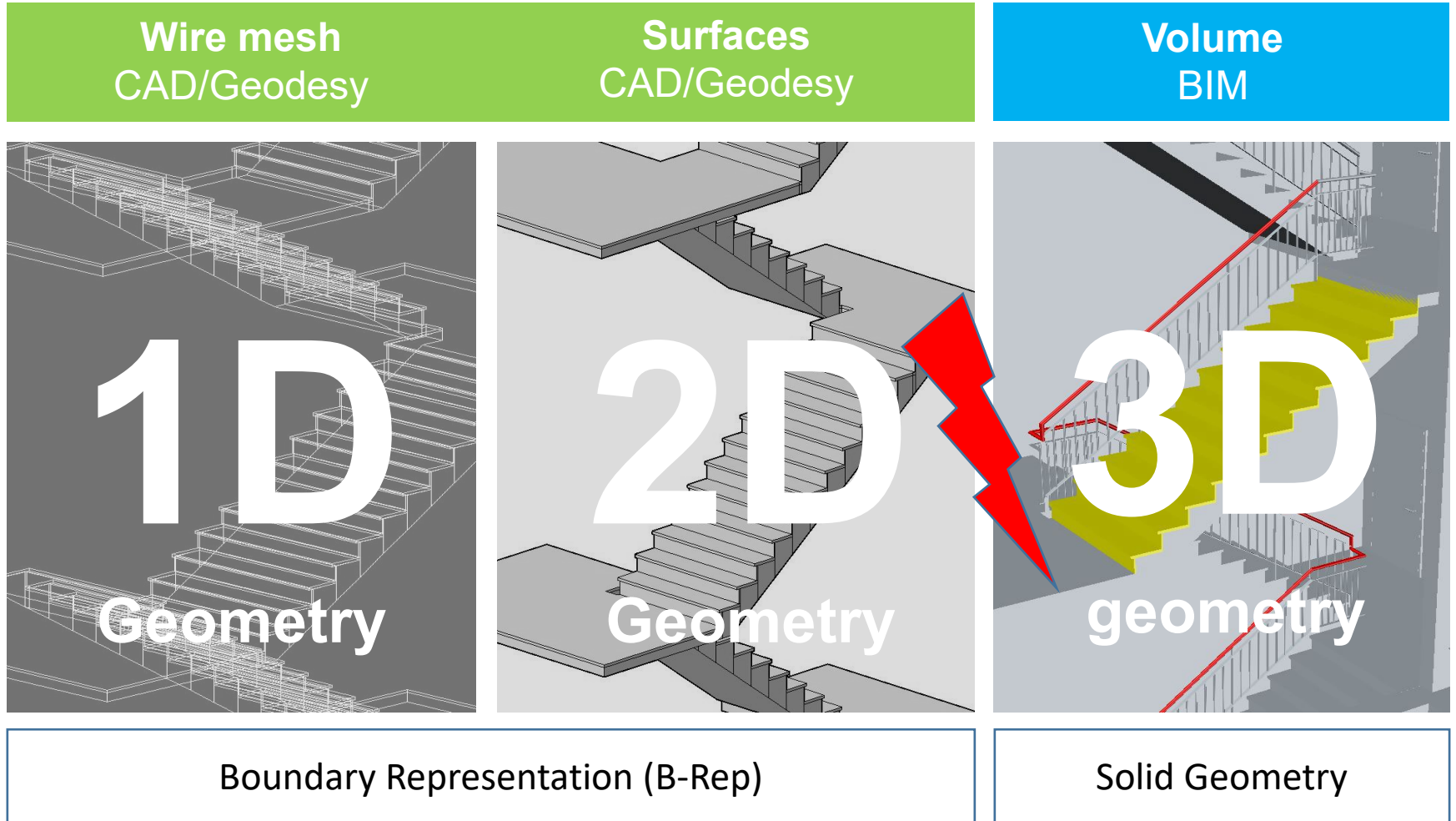

# Example: Data Models in BIM and GIS

## AEC Domain (IFC)

## Geo Domain (CityGML)

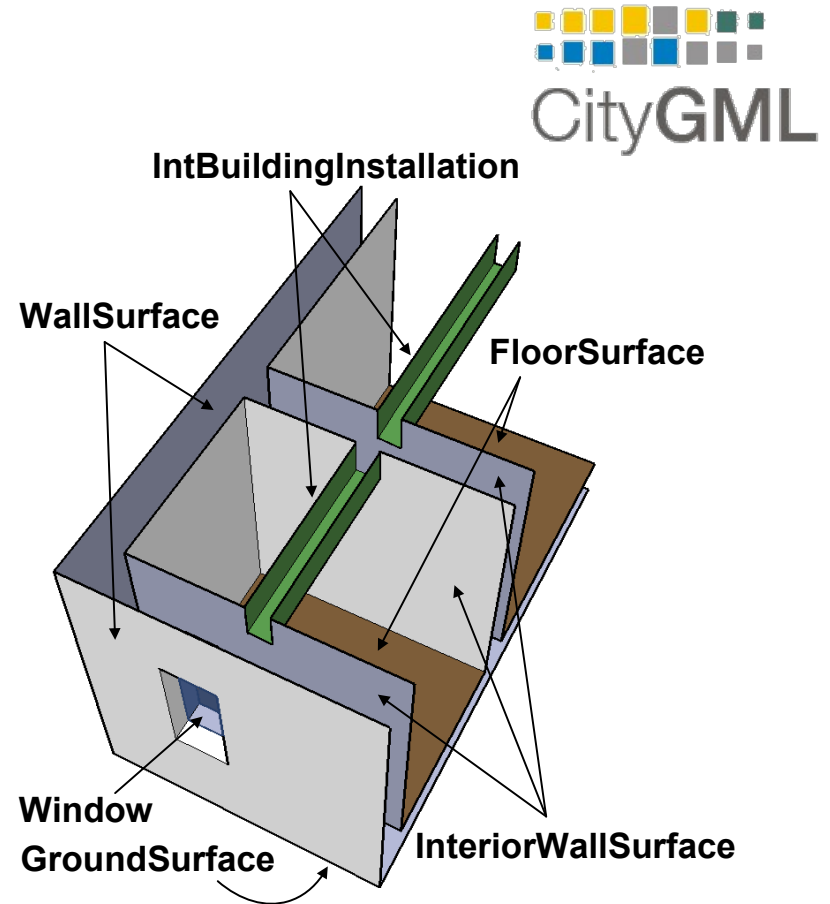
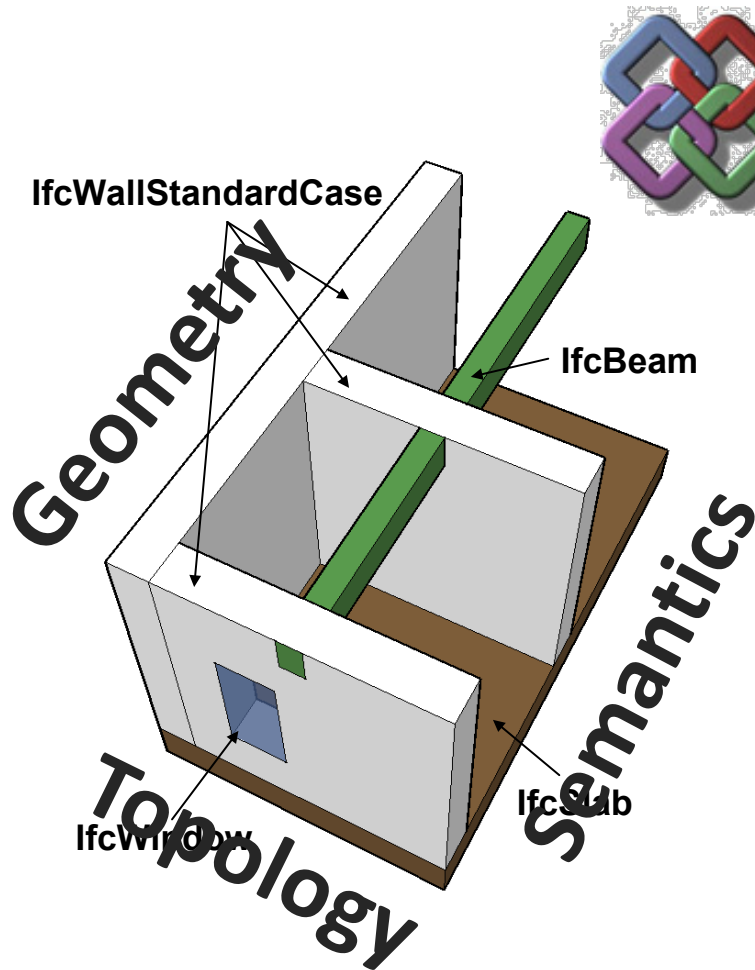

[T. H. Kolbe / C. Nagel]

# Geometric Modeling: Solid vs. B-Rep

## AEC Domain

### Parametric, Sweep, CSG

Combination of volumetric objects by Boolean operations

$\cup, \cap, \setminus$

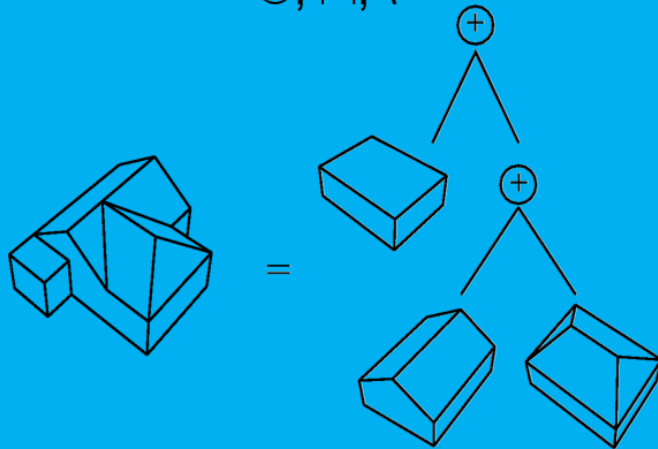

Particularly suitable for design and construction planning

## Geo Domain

### Boundary Representation (B-Rep)

Aggregation of all surfaces surrounding the volume

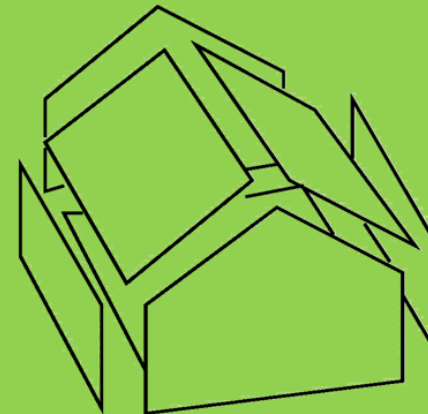

Especially suitable for acquisition from observations (measurement)

# Solid Modeling in BIM

- The basic geometric elements are solid types
- Solid types are combined into complex geometric objects using logical operations
- The creation of the model is saved, not the result → few coordinates, many sequential coordinate transformations

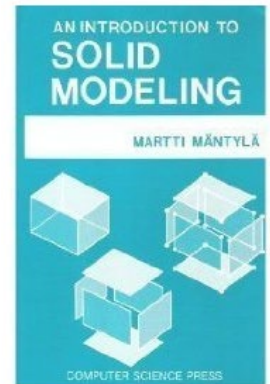
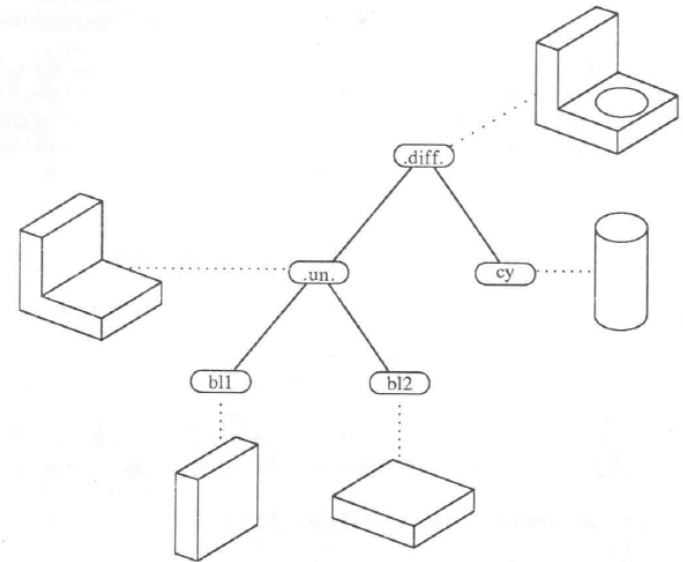

[Mäntylä, M: An Introduction to Solid Modeling, Computer Science Press, 1988]

# Concepts of Solid Types

- Parametric modeling
  - Solid objects with a limited set of parameters (length, width, height...)
  - Parameter values refer to the type or instance
- Constructive Solid Geometry
  - Defined set of basic geometric types
  - Composition through logical operators
- Sweep (extrusion and rotation)
  - Primitive: Modeling of a cross-sectional surface (profile)
  - Operation: Movement of the profile along a given vector

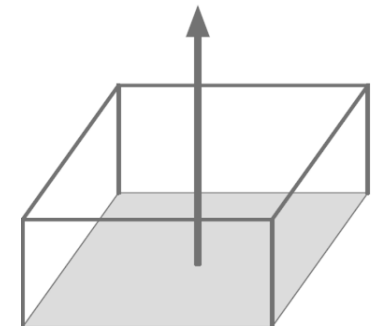
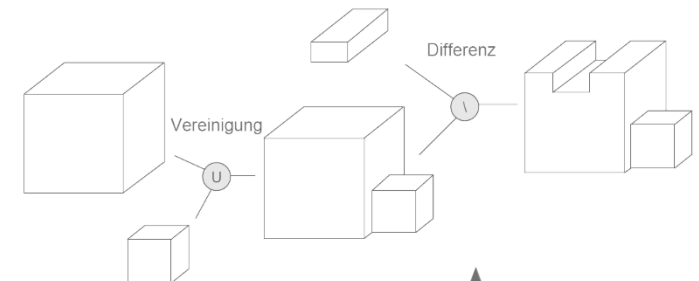
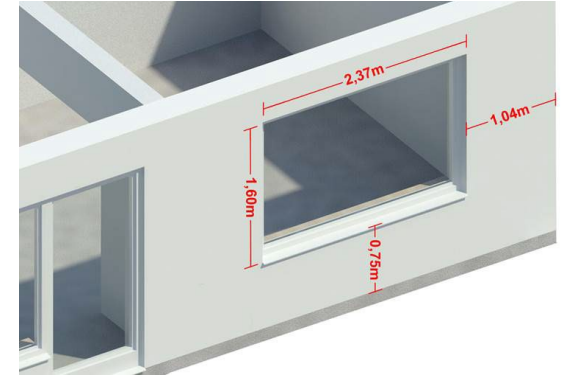

## Pro&Con of Volumetric/Solid Models

- Possibility of quantity determination (e.g. concrete) for costing and material ordering
- Derivation of 2D plans with correct material hatching (e.g. floor plan, sections and views)
- "unfamiliar" for GIS/surveying
- Corner points, edges and axes have no explicit coordinates
- Plugins required in BIM authoring software to create stakeout/coordinate lists

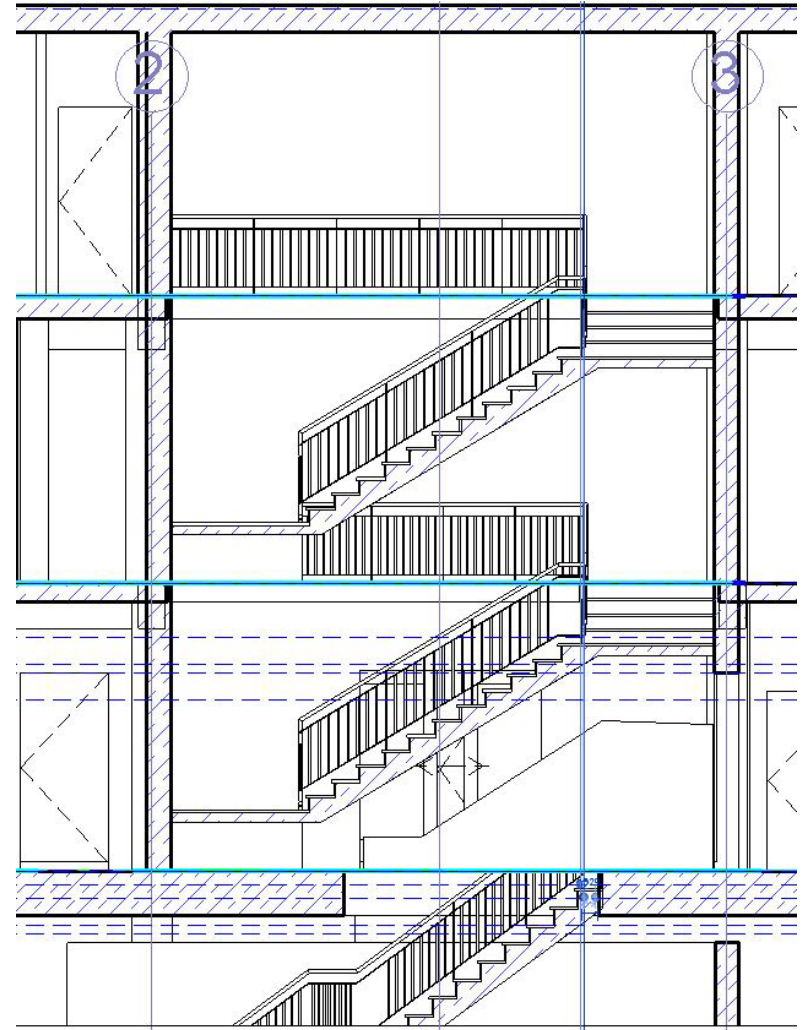



# Semantic Modelling

- Semantic information = factual data/non-graphical data
- Essential to meet the goal of BIM:
  - Machine readable (= "understandable") exchange of information
  - Automation of validation, filtering, modification, ...
- For comparison: Semantics in CAD
  - Graphical: drawing elements are grouped in layers, expressed by color, line style, etc. to classify points, lines and surfaces
  - Alphanumeric: block attributes or XDATA
- For comparison: Geodetic CAD
  - point code/line type/object designation/attributes

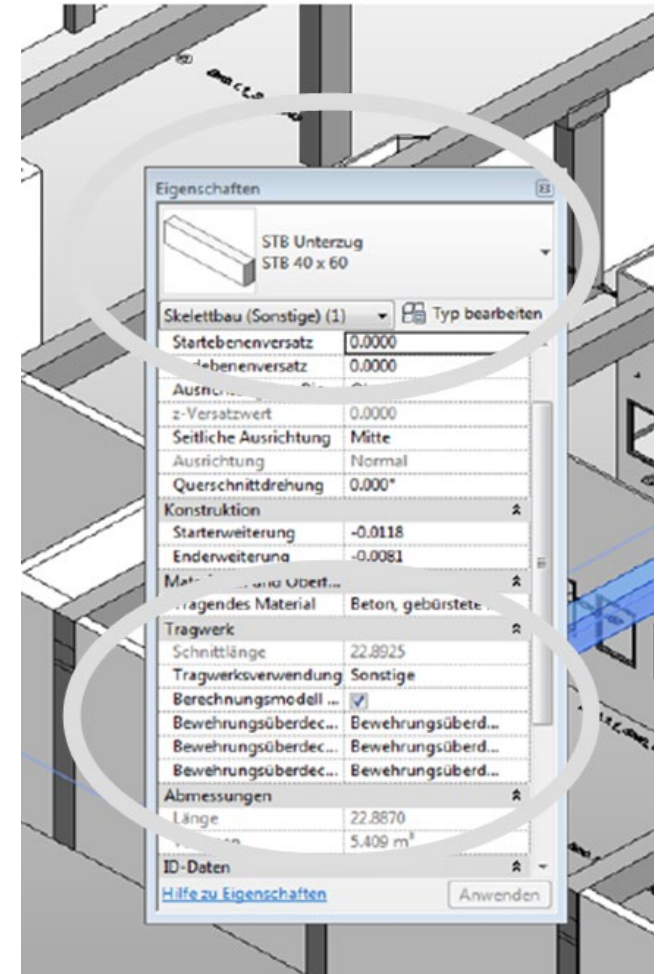



# Semantic Modeling in BIM (here: Revit)

- Classification of similar objects
- Attribution (atomic property-value pairs) of object-specific properties
- Hierarchy formation from coarse to fine

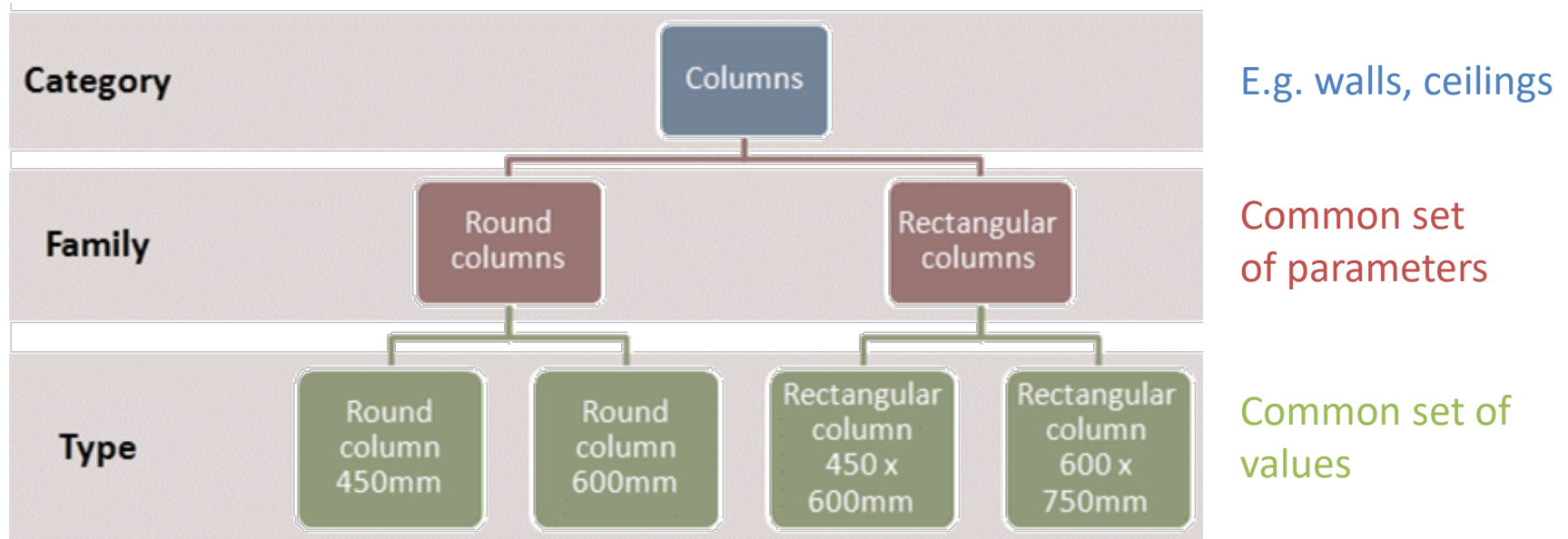

[<https://knowledge.autodesk.com/support/revit-products/learn-explore/>]

## Pro&Con of semantic (component-oriented) models

- Consensus on different areas of application and the specialist domains involved (architecture, construction, TGA, surveying)
- Detailed exchange of information between specialist domains on the basis of objects, e.g. wall as information carrier
- Machine interpretable and analyzable, e.g. creation of room/construction lists, determination of materials and costs
- As-built survey requires knowledge of building construction and materials, some of which are not observable
- Conflict with LOD concept in BIM

Raumliste						
Nummer	Fläche	Volumen	Belegung	Oberflächen		
				Fußboden	Wandoberfläche	Deckenoberfläche
5	115.37 SF	1673 CF	Shared	Ceramic Tile	White Painted	Acoustic Tile 2'x2'
27	1988.39 SF	28833 CF	Shared	Ceramic Tile	White Painted	Acoustic Tile 2'x2'
Flur : 2		2103.76 SF				
10	436.32 SF	6327 CF	Office	Ceramic Tile	Light Blue Painted	Acoustic Tile 2'x2'
13	313.14 SF	4541 CF	Office	Ceramic Tile	Light Blue Painted	Acoustic Tile 2'x2'
14	358.36 SF	5196 CF	Office	Ceramic Tile	Light Blue Painted	Acoustic Tile 2'x2'
15	350.66 SF	5085 CF	Office	Ceramic Tile	Light Blue Painted	Acoustic Tile 2'x2'
17	235.44 SF	3414 CF	Office	Ceramic Tile	Light Blue Painted	Acoustic Tile 2'x2'
18	235.44 SF	3414 CF	Office	Ceramic Tile	Light Blue Painted	Acoustic Tile 2'x2'
21	265.59 SF	3851 CF	Office	Ceramic Tile	Light Green Painted	Acoustic Tile 2'x2'
22	235.44 SF	3414 CF	Office	Ceramic Tile	Light Green Painted	Acoustic Tile 2'x2'
25	268.48 SF	3893 CF	Office	Ceramic Tile	Light Green Painted	Acoustic Tile 2'x2'
26	262.69 SF	3809 CF	Office	Ceramic Tile	Light Green Painted	Acoustic Tile 2'x2'
Büro : 10		2961.54 SF				

# Topology Modeling

- Simple definition: Topology describes the spatial relationships that are invariant to geometric transformations such as shifting, rotating and scaling
- Typical topological relations are
  - "is contained in",
  - "is the boundary of" or
  - "touches"
- Topological relations are either
  - Implicit – can be calculated from geometry (often in GIS)
  - or
  - Explicit (relations are stored in the model)

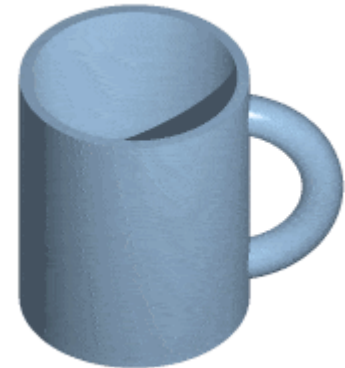

# Explicit Topological Modeling in BIM

- Indirect topology with reference elements
  - Vertical reference using horizontal planes
  - Horizontal reference through axes
  
- Direct topology
  - rule-based
  - Rules are by element type (semantics)

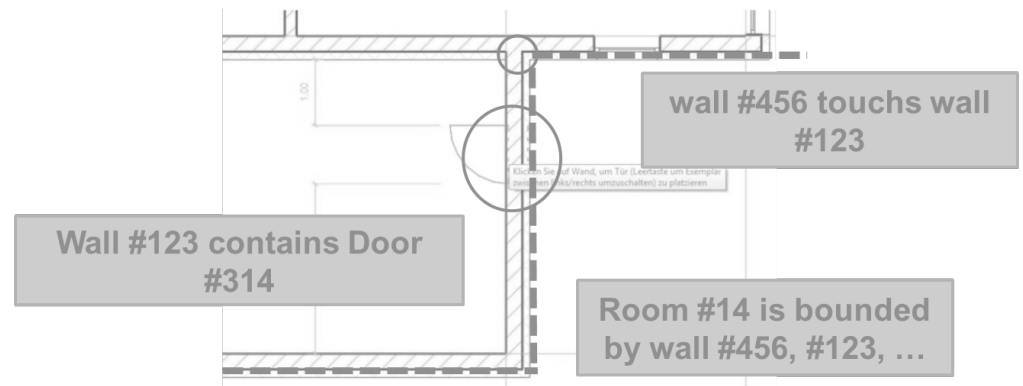
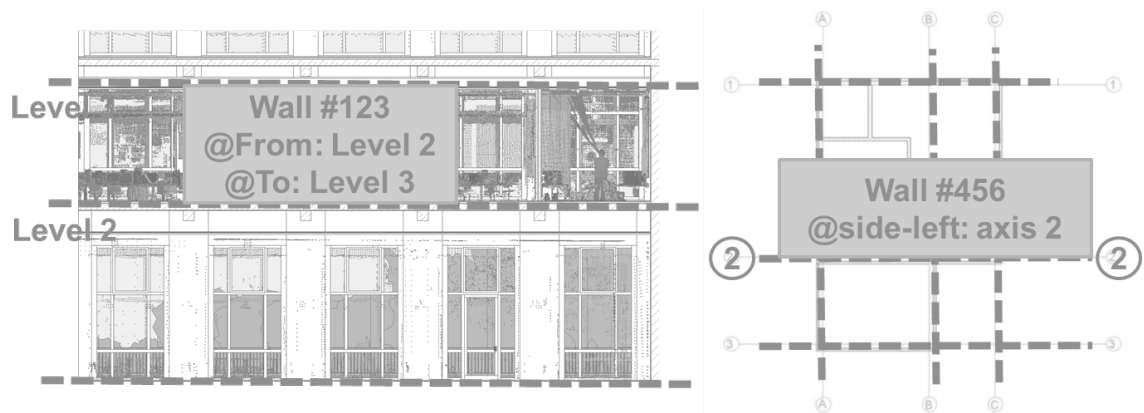

[Clemen, HTW Dresden]

# Topology Between Spaces (e.g. IFC)

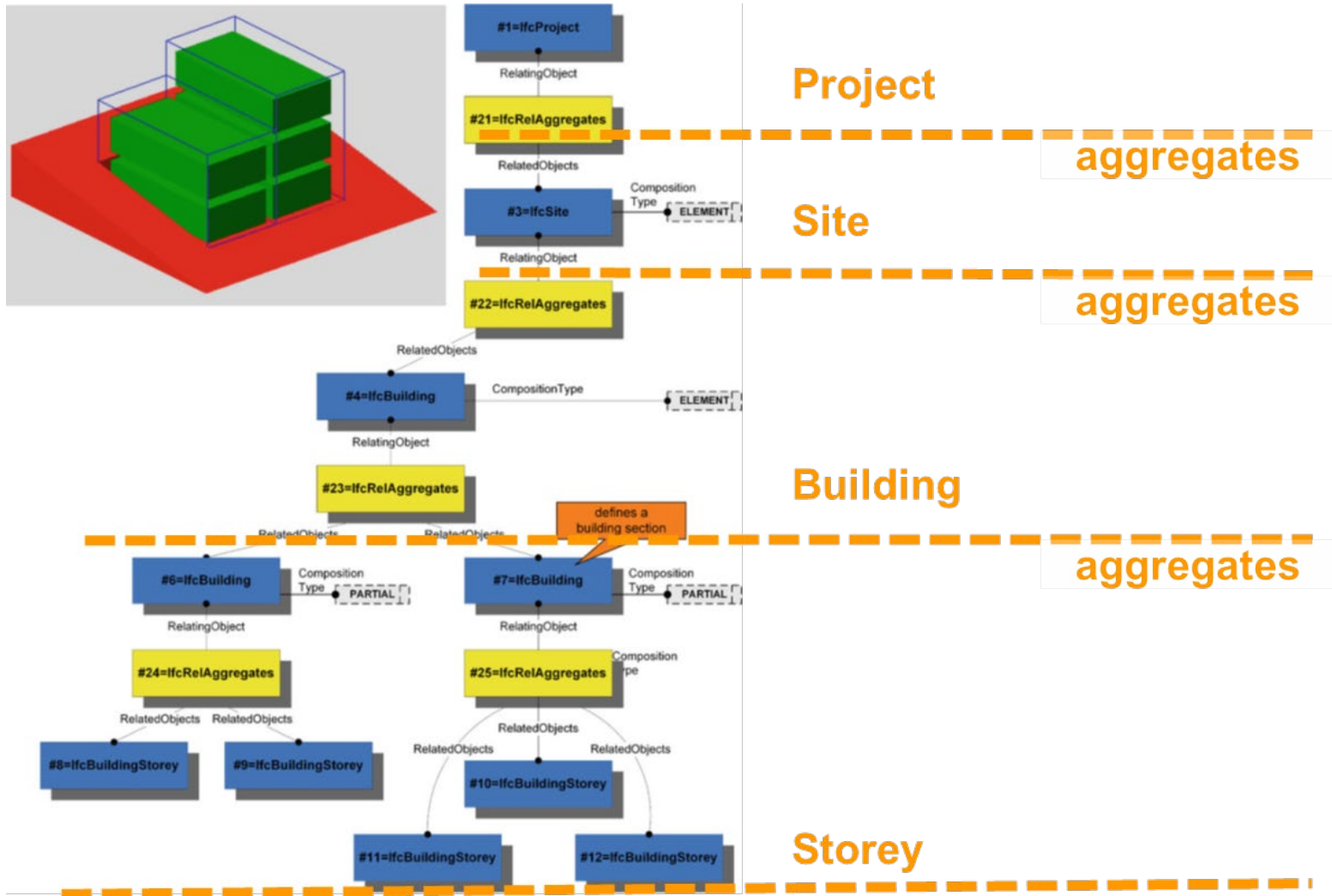

## Pro&Con Explicit Topology

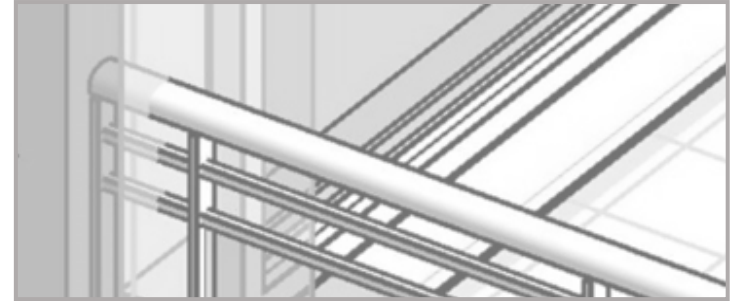
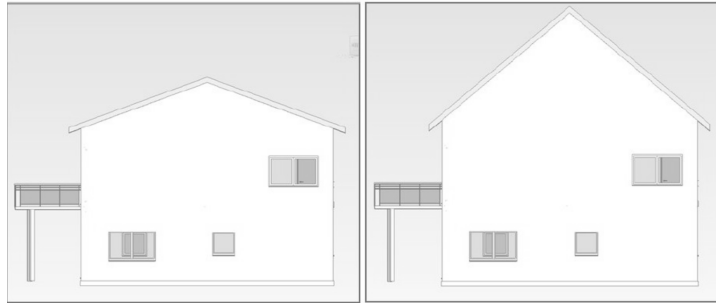

- Simple changes to the model through automatic adjustment of the affected geometric elements
- Automatic collision analyses by analyzing topological links and geometric spatial interpenetration of objects
- Topological concepts lead to conflicts during reality capture by surveying

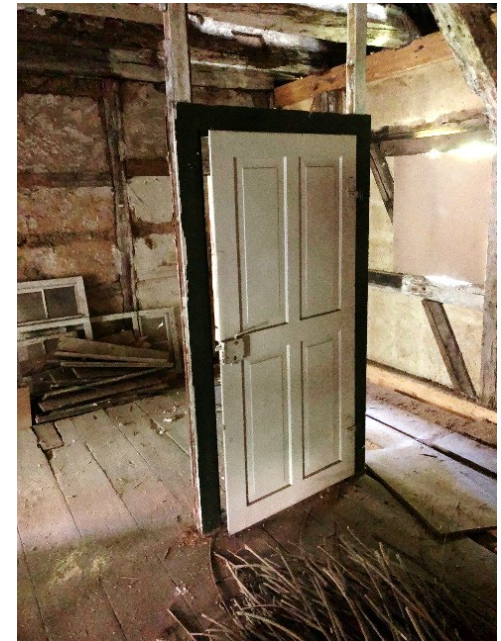



# BIM Use Cases in General

## A Use Case defines ...



- **who** needs
- which **information**
- at what **time**
- in which **format**
- in which **level of detail**

## Result of a Use Case:



- **common** understanding
- **integrated** processes
- inputs to **EIR** and **BEP**
- mapping to **IFC** schema
- basics for **MVD's**

(<https://ucm.buildingsmart.org/>)

# Examples: BIM Use Cases

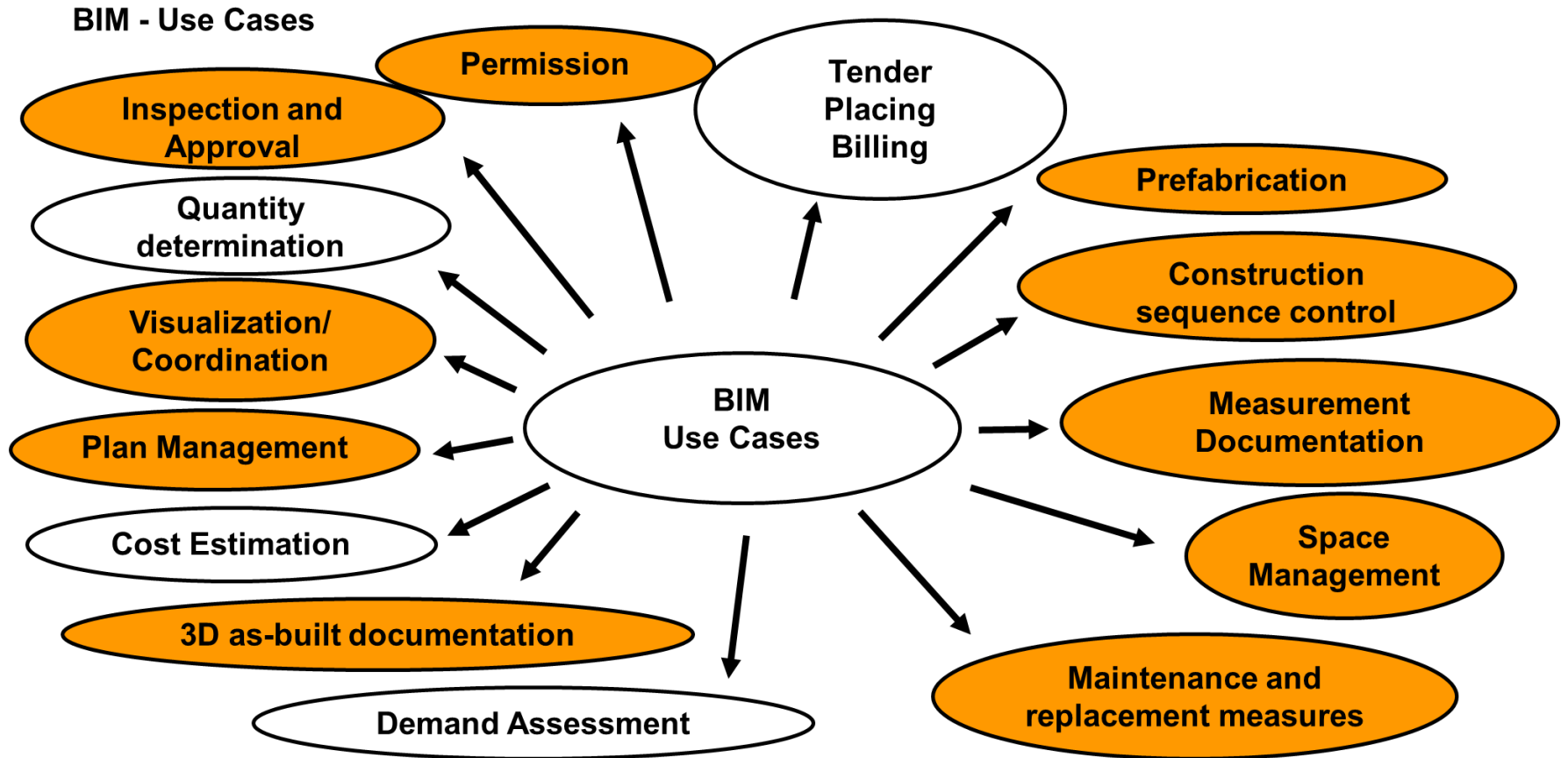

(C. Clemen, HTW Dresden)



# Geodesic Use Cases in BIM Processes

- Design/planning phase
  - Site plan and GIS data - link to real environment
  - Georeferencing
  - Spatial analysis - Location Intelligence and GeoAI
- Construction phase
  - Staking out
  - Construction supervision
- Operation/maintenance/renovation phase
  - Building survey (of the actual condition - Reality Capture)
  - Creation of a digital twin: As-Built or As-Is

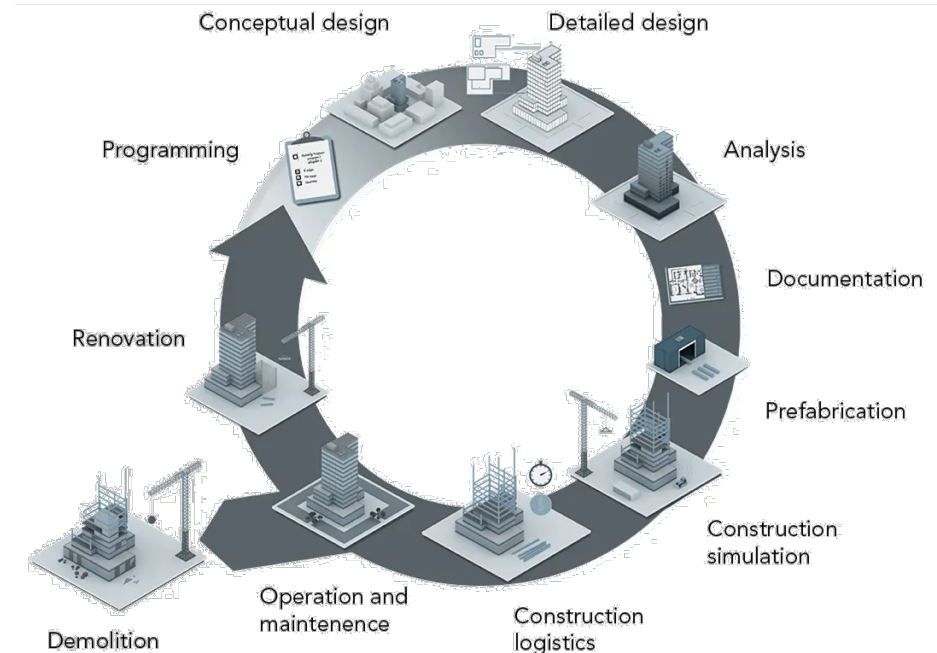

# Site Plan: Modeling of Outdoor Elements

- Terrain modeling
  - BIM software often only allows the import of terrain points that are re-triangulated
  - Not straight forward
- 3D landscape elements
  - BIM modeling concepts sometimes a hindrance for irregular elements
    - Topological concept
    - Parametric geometry
  - However, individual elements can be modeled (sometimes at great expense) using generic proxy elements

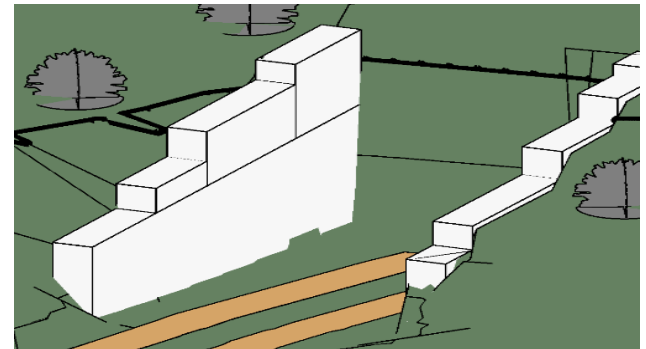
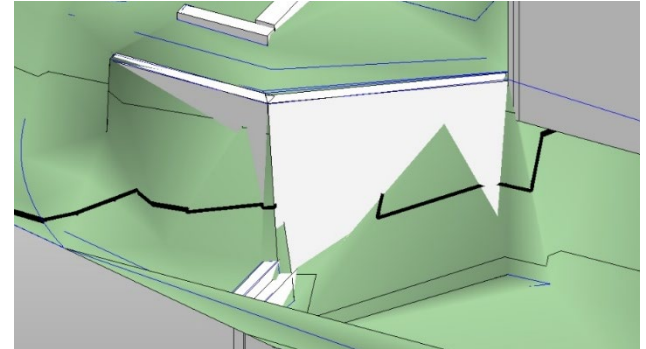

# Example Autodesk Revit

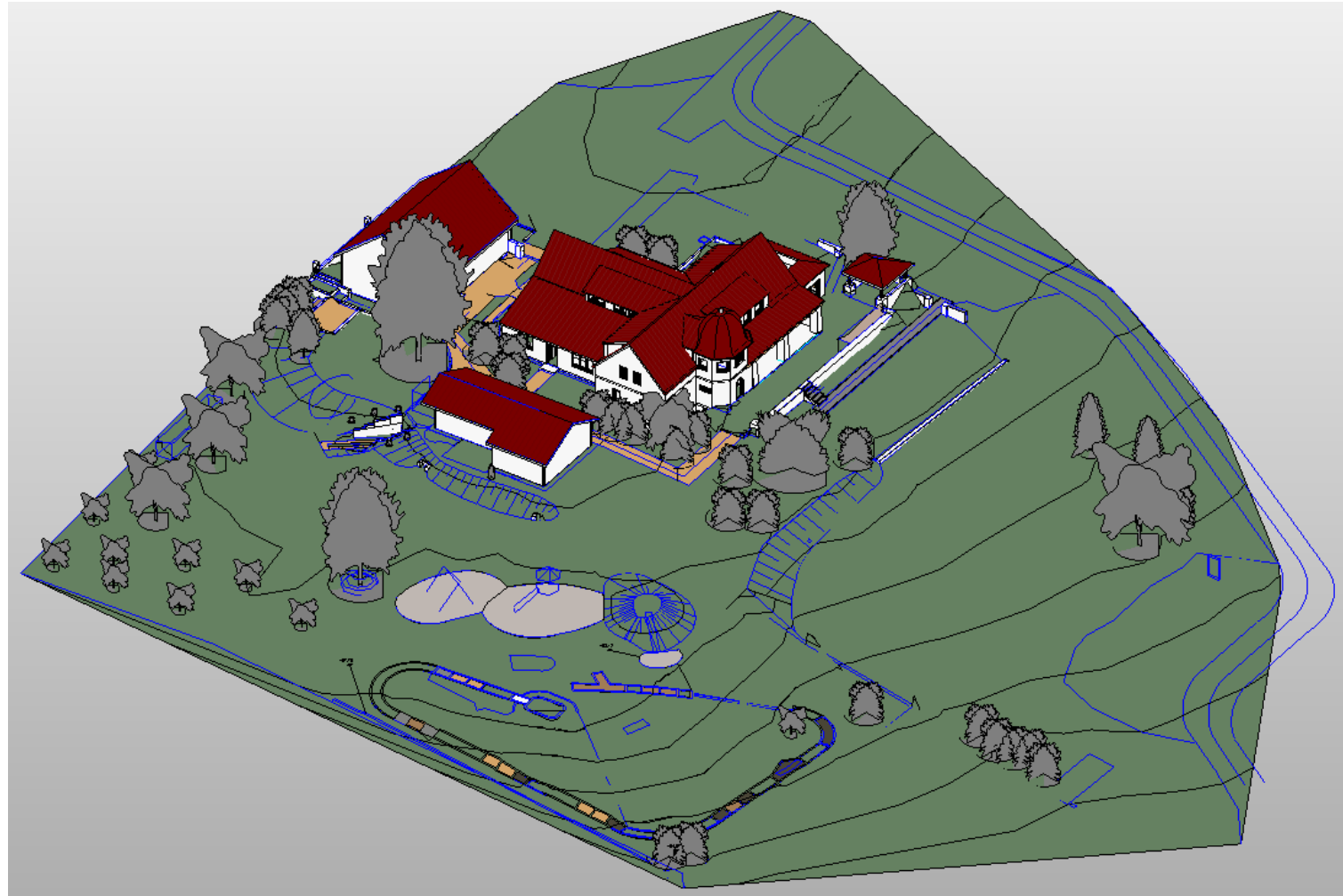

# Example Nemetschek Vectorworks

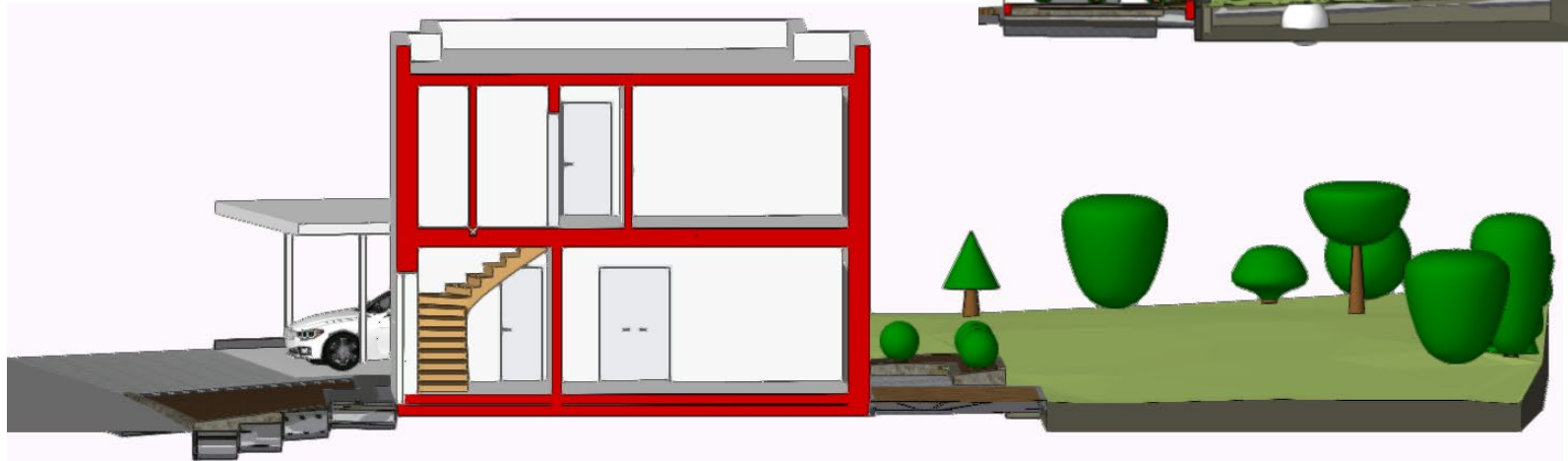
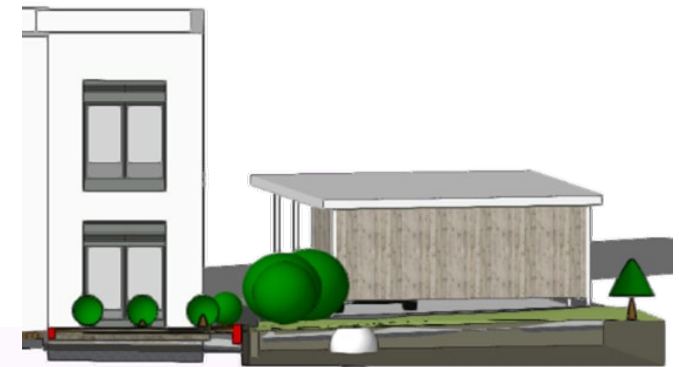

# Spatial Analyses of BIM Projects in GIS

- Integrated BIM-GIS analyses
- Effects of planning on the surrounding environment (buildings, vegetation, etc.)
  - Shadowing analyses
  - Visual analysis
- Impact of the surrounding environment on the planning
  - Solar potential analyses
  - Noise analysis





# Georeferencing – Single Building or Entire Project?

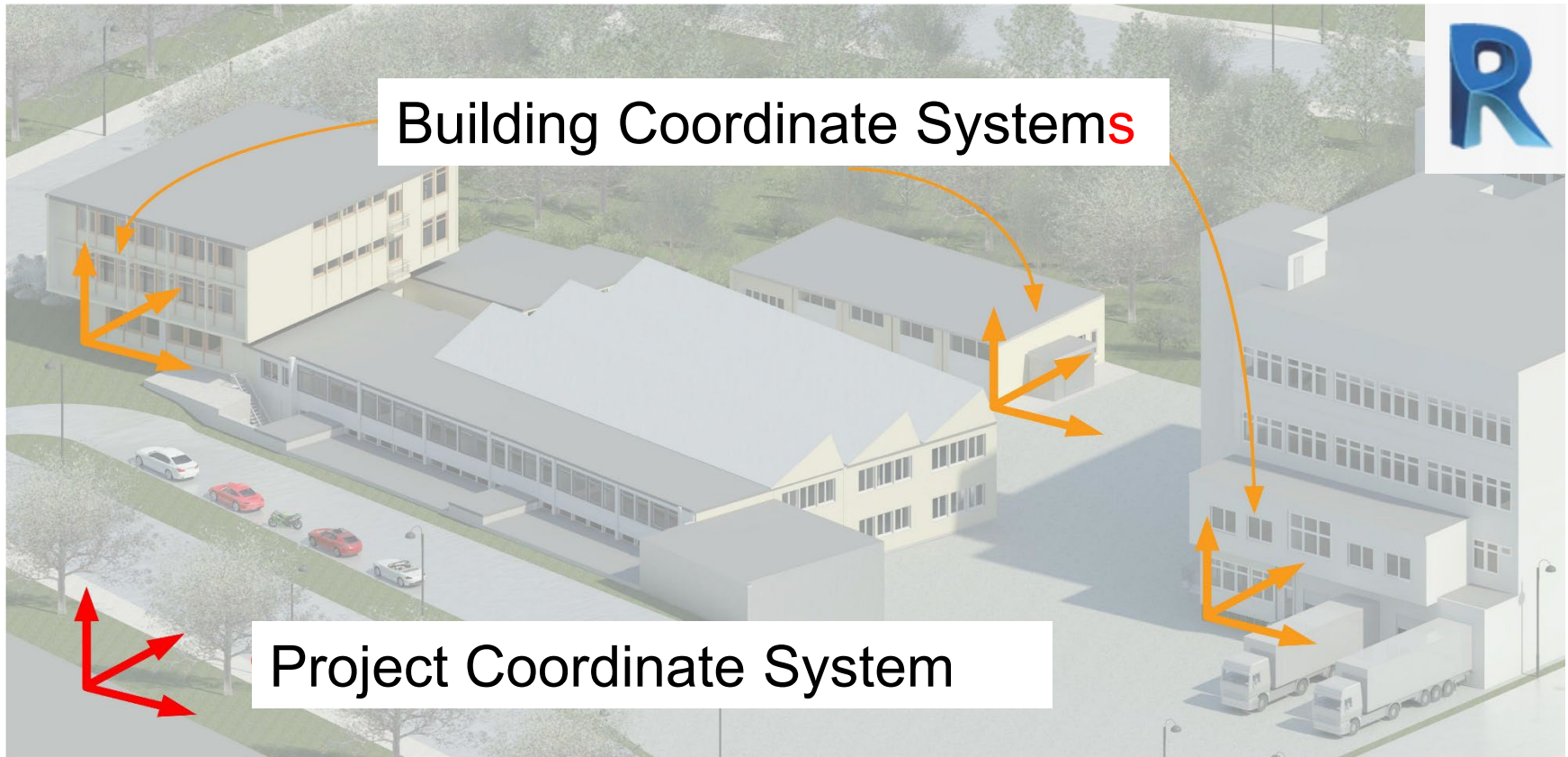

 Project Base Point

 Surveying Point... ?

(C. Clemen, HTW Dresden)

# Georeferencing of BIM Models (e.g. Revit)

- BIM authoring software generally works with scale-free, local coordinates → Limitation of the project scope
- No clear definition of geodetic reference systems
- Georeferencing of the BIM project usually by means of a translation and a rotation in one point
- Options for georeferencing in Revit
  - Manually move the project base point to a model point and enter the coordinates and rotation angle
  - Linking of a georeferenced CAD data set and transfer of the coordinates
  - By means of a chargeable plugin (Autodesk Point Layout (APL)) via two control points

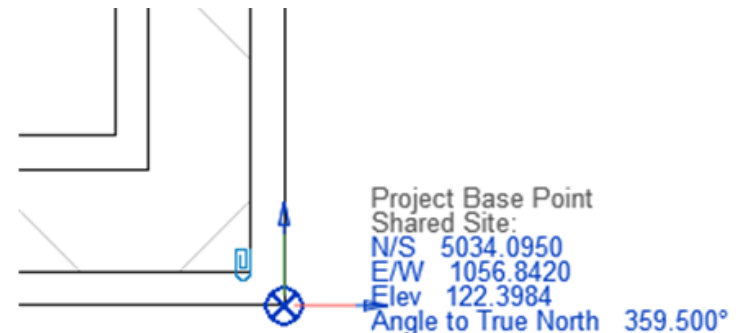

## Stakeout of BIM Building Points and Axes

- Due to parametric modeling, relative placement and sequential transformations of building components, elements are not represented by absolute coordinates
- Coordinates for staking out building corners or axes cannot be taken directly from the model
  - Either: Current on-board software from total station or field computer supports the processing of BIM models → Coordinates of the selected stakeout points are calculated on-the-fly from the model
  - Or: Stakeout points must first be defined on the PC by marking them in the graphic and the coordinates must be calculated and exported, e.g. using the Autodesk Point Layout plug-in for Revit

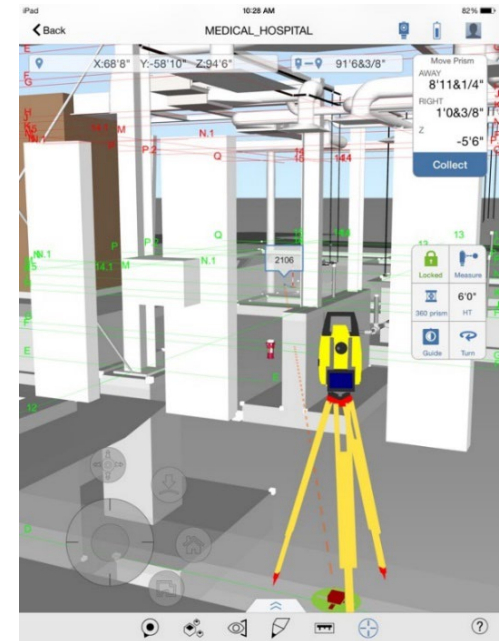

Autodesk® BIM 360™ Layout app for iOS



# BIM Based Digital Twins of Buildings (Scan2BIM)

- Integrated digital representation **of a real building** using linked models, data and algorithms
- Are application-specific and enable a comprehensive digital representation of the real building
- A key feature is the systematic, close coupling of real and virtual representation of the building for (real-time) data exchange and knowledge transfer
- Digital building twins can have several partial stages or level of development

Blankenbach, RWTH Aachen University, 2023



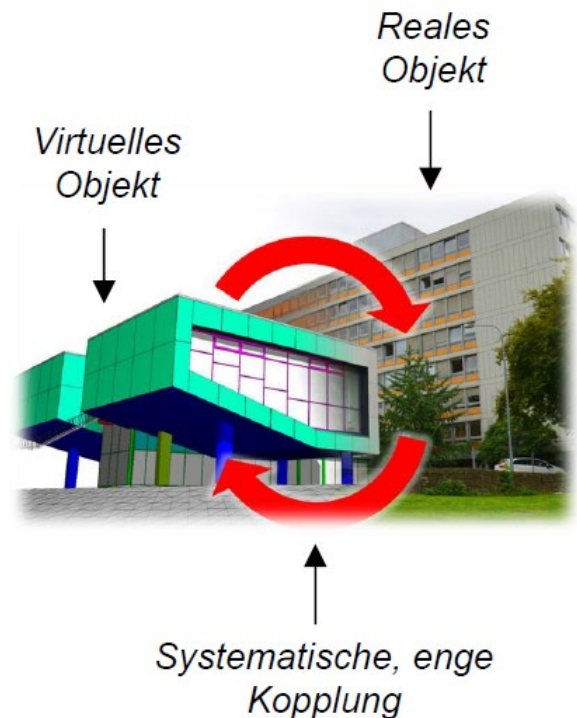

→ Digital twin - as-built or as-is?

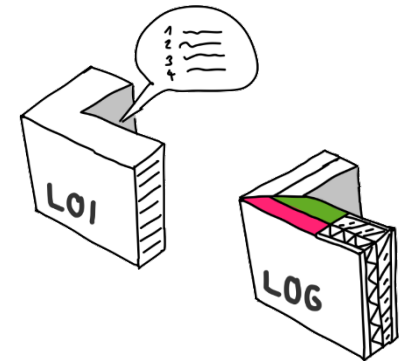

# As-Built Inventory Model

- Requires BIM execution model (LOD 400) as part of a BIM process
- As-built model (LOD 500) is created by comparing, if necessary, measurement and update of the as-built status
  - High alphanumeric information maturity level (*Level of Information (LOI)*)
  - High level of geometric detail (*Level of Geometry (LOG)*)



Conceptual Design Phase	Schematic Design Phase	Documentation/Tender/Planning Phase	Execution Phase	Operation and Maintenance Phase
<b>100</b>	<b>200</b>	<b>300/350</b>	<b>400</b>	<b>500</b>
GIS Maps, Masses & 2D Symbols	Partially-defined Geometry; Size, Shape, Position, Orientation.	Specific/Precise Geometry; Size, Shape, Position, Orientation, Connections.	LOD 300/350 + supplementary geometry for fabrication eg, holes, welds, nails, nuts, bolts, and screw sizes.	LOD 400 + All objects As-built and installed.
				

(Source: <https://medium.com/>)

# As-is Inventory Model

- No BIM execution model (LOD 400) available, BIM process begins with the building survey
- As-is model is created through observations and modeling of the as-is condition, including geodetic methods, interpretation of the construction, condition diagnostics, document research, etc.
  - In contrast to the as-built model different LOD levels are possible
  - LOI and LOG depending on the depth of knowledge of the observations



# Quality Levels As-Is Construction Survey

Qualitätsstufe	Q1	Q2	Q3	Q4	Q5
<b>Maßstäbe</b>	<b>M1:200 / M1:100</b>	<b>M1:100 / M1:50</b>	<b>M1:50/M1:25</b>	<b>M1:20/M1:10</b>	<b>M1:5 / M1:1</b>
Beschreibung	Schematisches Aufmaß / Modell	Einfacher Plansatz Modell	Detailliertes Gebäudeaufmaß / Planungsmodell	Verformungsgereue Dokumentation / As-Build-Modell	Detailaufmaß / Bauteilmodell
<b>Genauigkeit</b>	<b>G1</b>	<b>G2</b>	<b>G3</b>	<b>G4</b>	<b>G5</b>
	Genauigkeit <= +/- 5 cm	Genauigkeit <= +/- 2,5 cm	Genauigkeit <= +/- 2 cm	Genauigkeit <= +/- 1cm	Genauigkeit <= +/- 0,25cm
DIN 18710-1	L1	L2/H1	L3/H2	L4/H3	L5/H4-H5
<b>Semantik S1-S5</b>	<b>S2</b>	<b>S2</b>	<b>S3</b>	<b>S4</b>	<b>S4</b>
<b>DIN 1356-6</b>	Informationsdichte 1	Informationsdichte 1	Informationsdichte 2	Informationsdichte 2	Informationsdichte 2
<b>„Eckstein“</b>	Eckstein Stufe I	Eckstein Stufe II	Eckstein Stufe III	Eckstein Stufe IV	Eckstein Stufe IV
	geringe Detaillierung	mittlere Detaillierung	hohe Detaillierung	sehr hohe Detaillierung	höchste Detaillierung
<b>2D Pläne</b>	<b>P1</b>	<b>P2</b>	<b>P3</b>	<b>P4</b>	<b>P5</b>
2D-Daten	schematische Zeichnungen	P1 + Grundrisse, Schnitte, Ansichten	P2 + zusätzliche Schnitte	P3 + Detailzeichnungen	P4 + nach Vereinbarungen
<b>3D Modelle</b>	<b>M1</b>	<b>M2</b>	<b>M3</b>	<b>M4</b>	<b>M5</b>
BIM-konforme 3D-Modelle	Schematisches 3D-Modell	BIM (Building Information Modell)	M2 + Verformungsgereutes Modell	M3 + verformungsgereutes Bauteilmodell mit Freiformflächen	M4 + vollflächig verformungsgereutes Oberflächenmodell
HOAI Leistungsphase	LPH1 Grundlagen - LPH2 Vorplanung	LPH3 Entwurf – LPH4 Genehmigungsplanung	LPH5 Ausführungsplanung	LPH5 Ausführung – LPH 6 Vergabe	LPH8 Überwachung + Dokumentation
BIM-Modell LOD (= LoG + Lol)	LOD 100	LOD 100 bis 200	LOD 200 bis 300	LOD 300 bis 400	LOD 400 – 500

L. Sörensen; Fundamentals: Recommendations for construction documentation (Eckstein), DIN 18710 (Accuracies in engineering surveying), DIN 1356-6 (Construction survey drawings)

## As-Is Acquisition (Scan2BIM)

- **Observable surfaces** are systematically scanned by a laser beam in defined angular steps
- Non-contact method with measuring rates of up to several million points per second
- A discrete set of 3D points (3D point cloud) is created

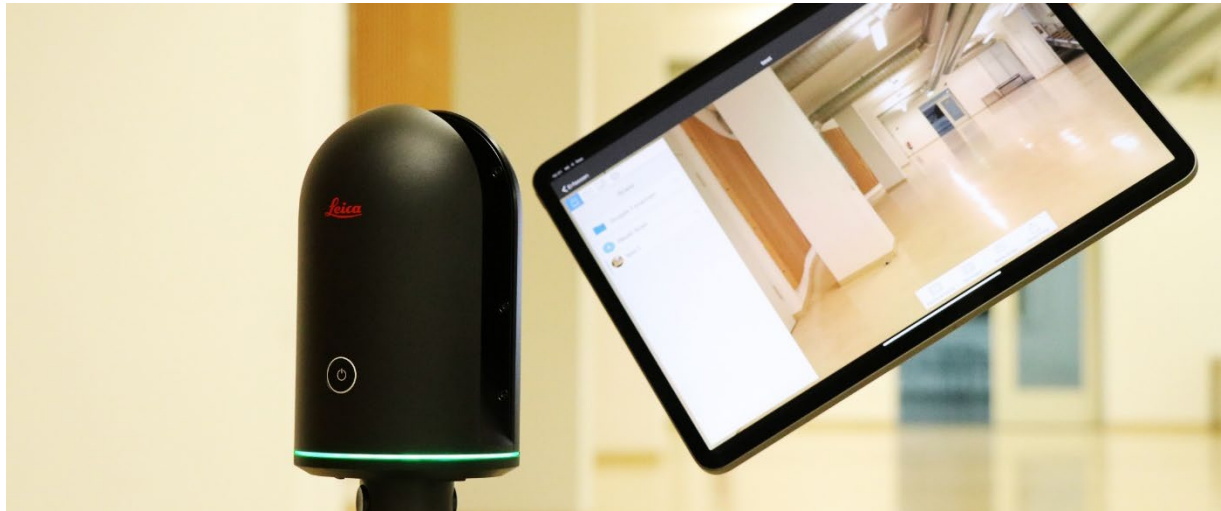



## Example Project - City Villa vs. Monastery Building

Urban villa in Bauhaus style with predominantly regular and rectangular building construction



Gothic monastery building with irregular and curvilinear construction features



# Registered Point Clouds

Point cloud of the urban villa visualized in **Leica Cyclone Register 360**

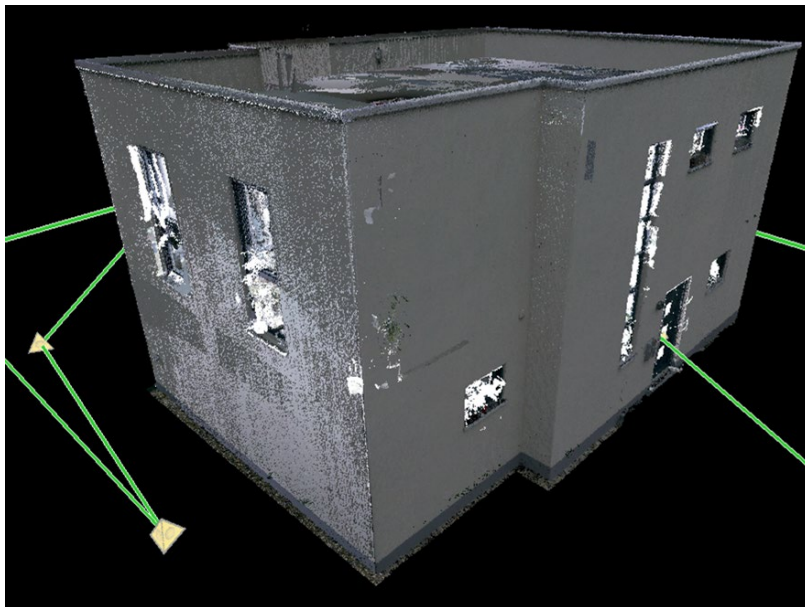

Point cloud of the Gothic monastery building visualized in **Autodesk ReCap Pro**

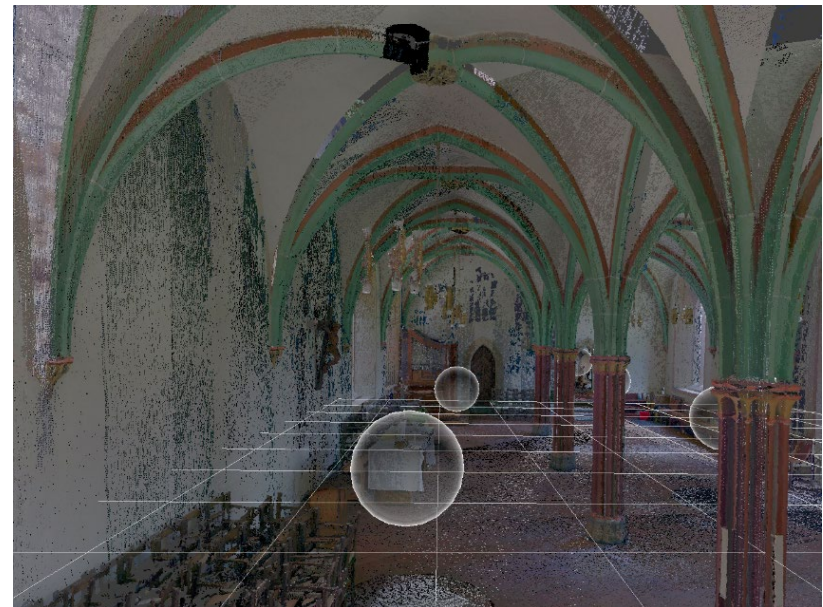



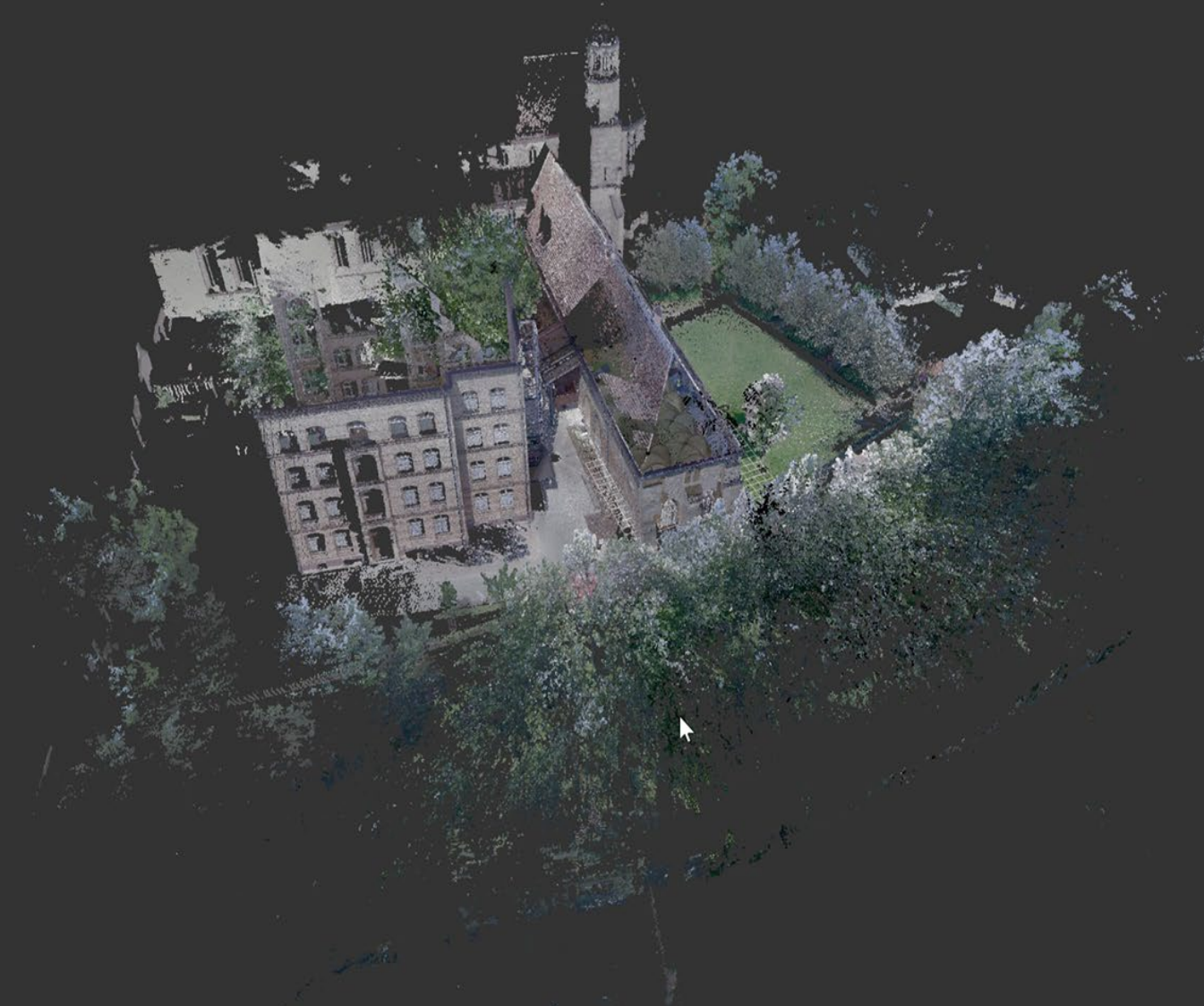

Prof. Dr.-Ing. Robert Kaden and Prof. Dr.-Ing. Christan Clemen

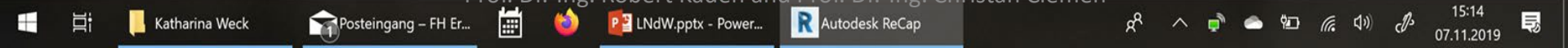

# BIM Authoring Software

## **Allplan with Scalypso**

- Original CAD software from the Nemetschek Group
- Further development towards BIM-capable component-oriented software
- Initially offers no native option for importing point clouds into a project and working directly in them
- Scalypso plug-in enables the loading and processing of terrestrial and mobile laser scan data in Allplan

## **Revit with Faro As-Built**

- BIM software from Autodesk
- In contrast to Allplan, offers the option of loading point clouds directly into a project and working in them
- However, no 3D point snap directly in the point cloud and no use in the family editor for creating prototype components
- Faro As-Built plug-in enables the extension of point cloud processing functions

# Modeling of the Bauhaus Style City Villa

- In both BIM authoring software, it was possible to almost exclusively use predefined construction elements
- Construction of all structural components such as walls, attics, ceilings, floor slabs and the floor structure by adapting the predefined construction elements (families)
- Door, window and window frame elements including roller shutter box and roller shutter rail were partially modeled individually using the point cloud (Revit: family editor)
- Corresponding tools for semi-automatic modeling based on the point cloud geometry are available in both BIM authoring software and plug-ins

# Example: Modeling the Walls

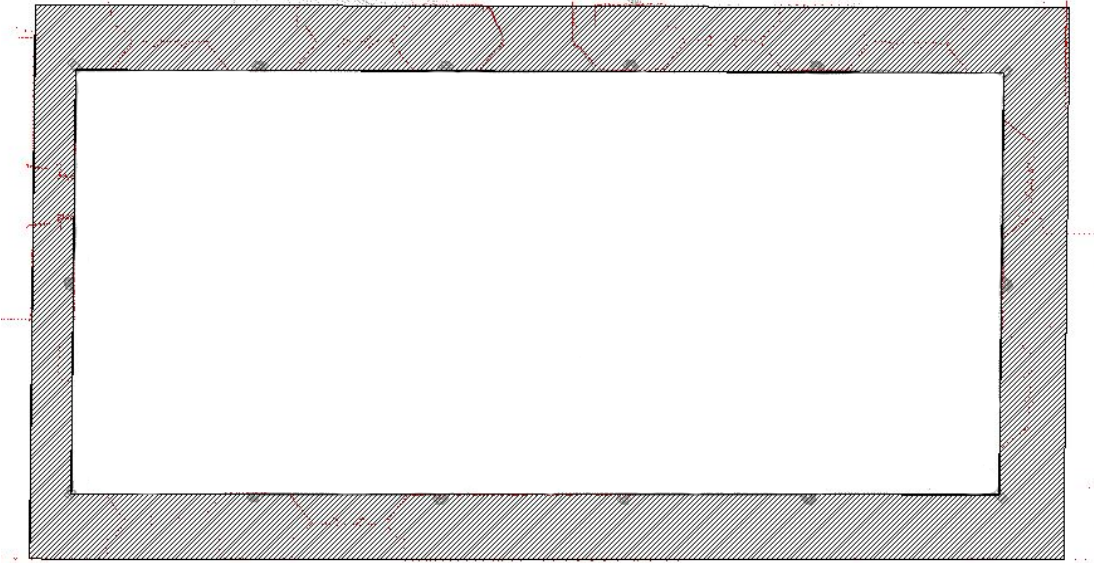
Allplan model	Revit model
<p>Automated modeling possible with the Scalypso and As-Built add-on programs</p> 	
<p>No automatic detection of wall thickness</p>	<p>Automatic detection of the wall thickness by taking points on the inside and outside of the wall</p>

# BIM Model of the Bauhaus Style City Villa

...with selected wall in standardized wall dimensions, visualized in the BIM authoring software Revit from Autodesk

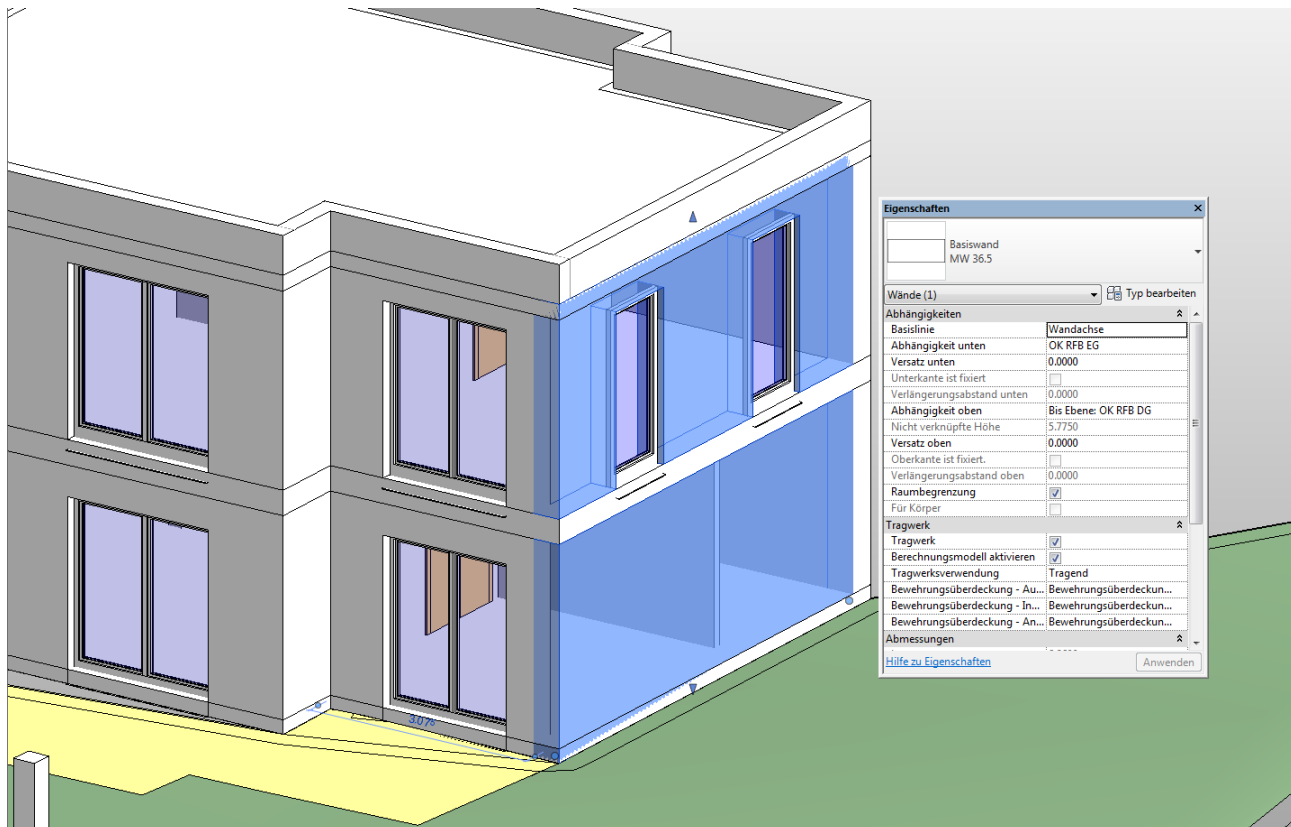

# Modeling of the Gothic Preacher Monastery

- As expected, it turned out to be much more complex and therefore more time-consuming
- Except for parts of the outer walls, no predefined construction elements could be used in the respective BIM authoring software Allplan and Revit
- Limited use of tools available to support modeling
- Most of the components could only be created manually as generic proxy elements with individual geometry
- The majority of the components such as ribs and caps had to be modeled individually in each vault section, as these elements were apparently repeated in the ceiling construction, but differed too much within the scope of the desired geometric accuracy



# Beispiel: Revit with Faro As-Built Plugin

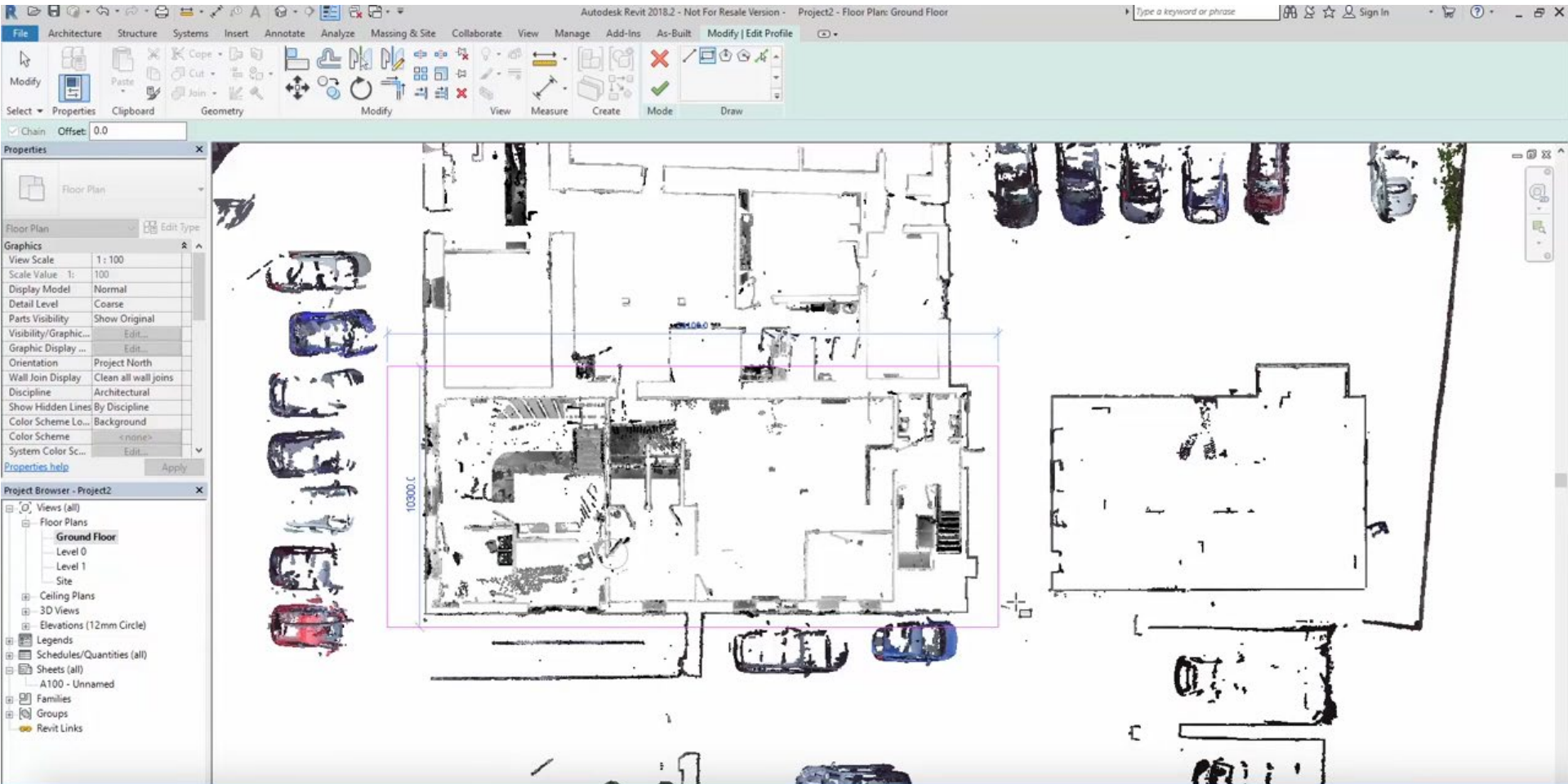

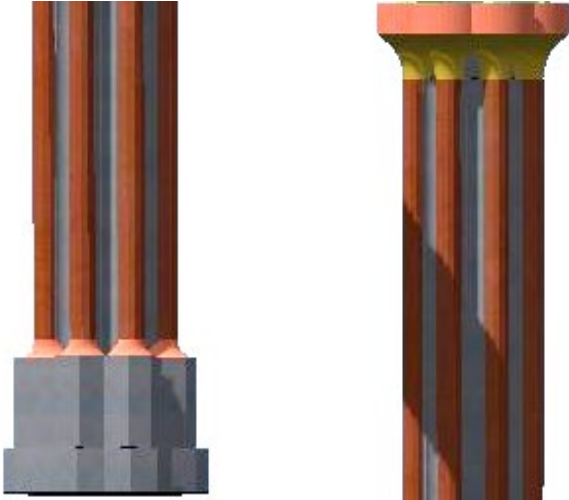
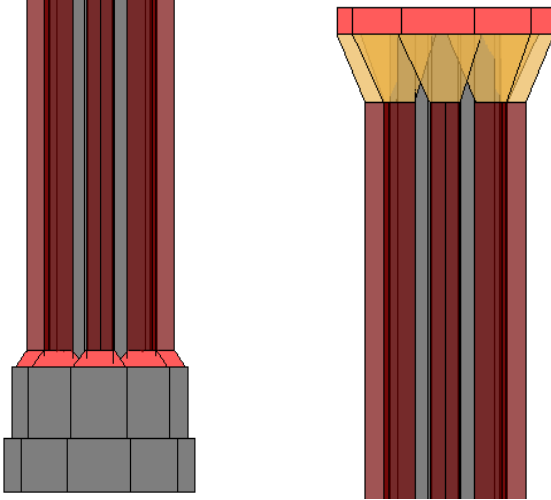

# Example: Modeling the Bundle Pillars

Allplan model	Revit model
Free modeling along the points from the point cloud (extrusion, path sweep and merging)	
 <p>The Allplan model shows two bundle pillars. The left pillar has a grey base with three vertical columns. The right pillar has a grey base with three vertical columns and a yellow and red top section.</p>	 <p>The Revit model shows two bundle pillars. The left pillar has a grey base with three vertical columns. The right pillar has a grey base with three vertical columns and a red top section with a yellow and red top section.</p>

# Example: Modeling the Ribs

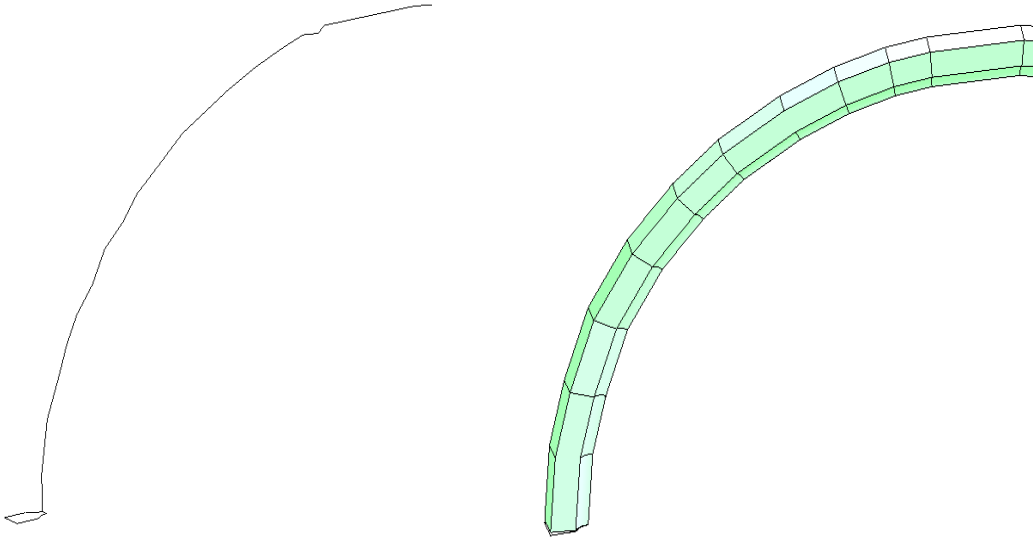
Allplan model	Revit model
<ul style="list-style-type: none"><li>• Capturing the rib courses from the point cloud using the additional plugins Scalypso and As-Built and transferring them as 3D lines in Allplan or Revit</li><li>• Extrusion of the previously constructed rib cross-section along these lines</li></ul>	
	

# Example: Modeling the Caps

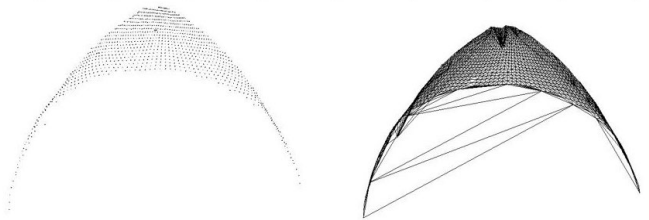
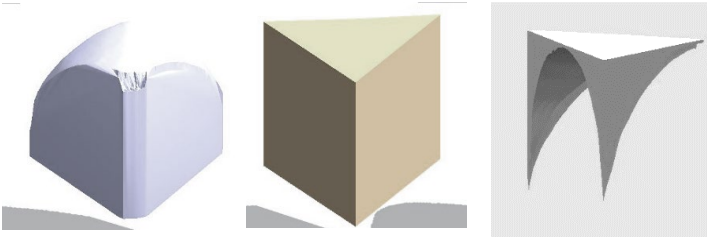
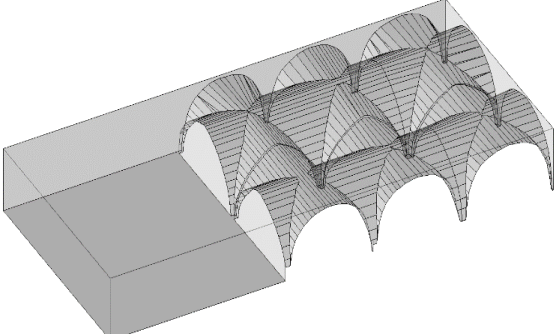
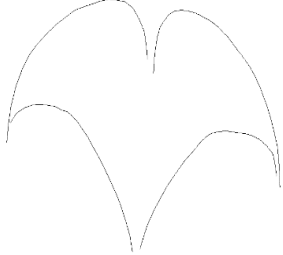
Allplan model	Revit model
<ul style="list-style-type: none"> <li>Transferring points from the point cloud to Allplan</li> <li>Transfer of these 3D points into a digital terrain model</li> </ul>  <ul style="list-style-type: none"> <li>Converting the terrain model into a 3D body</li> </ul> 	<ul style="list-style-type: none"> <li>Idealized modelling of the caps via two intersecting barrel vaults</li> </ul>  <ul style="list-style-type: none"> <li>Capturing the shape of the barrel vault from the point cloud</li> </ul> 

# Problem: Modeling the Caps

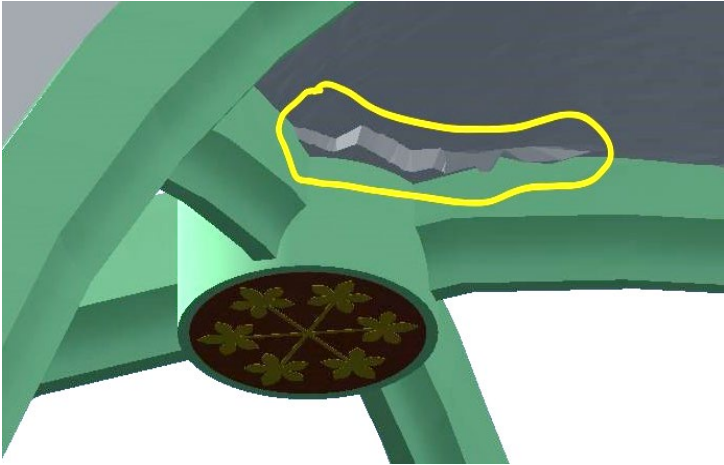
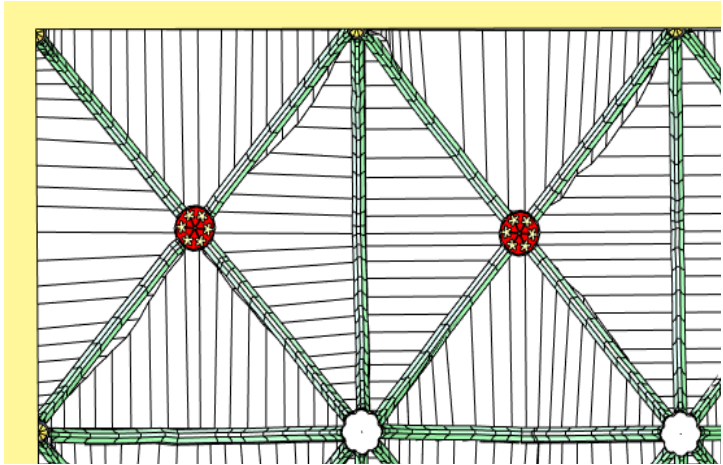
Allplan model	Revit model
<p data-bbox="208 406 923 492">Fraying at the points where caps and ribs meet</p> 	<p data-bbox="1045 406 1773 592">Course of the intersecting barrel vaults are not in exactly the same position as the ribs previously derived from the point cloud</p> 





# Summary Geodesy Domain vs. AEC Domain I

Differences (selection!)	Geospatial / GIS	AEC / BIM
<b>Model intention</b>	<b>descriptive</b>	<b>prescriptive</b>
<b>Model creation</b>	Few authors (commissioned data collection by the state or large companies)	Many authors (property planners, specialist engineers, operators from various companies)
<b>Typical Products</b>	PostGIS, Q-GIS, ESRI (a lot of very good Open Source 😊 )	Revit, ArchiCAD, Allplan, Solibri, Trimble... (lack of OpenSource 😞)
<b>Pre-Standardization</b>	OGC	buildingSmart
<b>Software Architecture</b>	More service-oriented (at least theoretically)	More file-based (at least currently), Container for snapshots
<b>Main „Product“ ?</b>	Digital model (data set)	Physical things (windows, constr. work)

## Summary Geodesy Domain vs. AEC Domain II

Differences (selection!)	Geospatial / GIS	AEC / BIM
Vendor-neutral data exchange	GML (CityGML, InfraGML, Ger: ALKIS/NAS)	IFC
Meta model languages	UML	EXPRESS
Conceptual Basis (Geometry)	ISO 19107 (Spatial Schema, conceptual schemas for describing, representing and manipulating the spatial characteristics of geographic entities. Vector data)	ISO 10303-42 (STEP) Industrial automation systems and integration -- Product data representation and exchange -- Part 42: Integrated generic resource: Geometric and topological representation
Coordinates	absolute, georeferenced	relative, local
Geometry-Representation	Simple Surfaces (B-Rep)	Hybride Models (Parametric, CSG, B-Rep)



# Best Practice and Research Reports

- ERASMUS+ - Teaching BIM and Surveying - Alexander Bong (Germany)
- Methods of Digital Construction - Babatunji Adegoke, Nigerian Institute of Quantity Surveyors (MNIQS, Nigeria)
- GIS2BIM - Process automation with FME - Christoph Frey (Germany)
- Effective Land administration and management through efficient use of financial management tools - Enyinna Tochukwu, (MNIQS, Nigeria)
- Integrative BIM-GIS planning process of renewable energy plants - Robert Jurzitza (Germany)

## Active work in groups (Bring your own expertise! Choose one)

- What are the pain points for not working with BIM?
  - Do you have any project experiences?
  - What could be better with BIM?
  - What are the drawbacks working with BIM?
- Successful use cases for “surveying (engineering and catastral) and BIM”
  - What are the benefits of using BIM in surveying projects?
  - How is the situation in your country? Is BIM in use during surveying project?
  - How is the legal frame in your country?
- Successful use cases for “geodata and BIM”
  - How is the availability and quality of open geodata in your country?
  - How are the interfaces/GDI?
  - How could geodata support BIM projects?

# Discussion and Closing

- Presentation of groupwork
- Discussion
- Closing Note by Commission 10 Chair Mercy Iyortyer